

USER'S MANUAL



t.c. electronic | *G-Force*
ULTIMATE SOUND MACHINES | GUITAR EFFECTS PROCESSOR

IMPORTANT SAFETY INSTRUCTIONS



The lightning flash with an arrowhead symbol within an equilateral triangle, is intended to alert the user to the presence of uninsulated "dangerous voltage" within the product's enclosure that may be of sufficient magnitude to constitute a risk of electric shock to persons.



The exclamation point within an equilateral triangle is intended to alert the user to the presence of important operating and maintenance (servicing) instructions in the literature accompanying the product.

- 1 Read these instructions.
- 2 Keep these instructions.
- 3 Heed all warnings.
- 4 Follow all instructions.
- 5 Do not use this apparatus near water.
- 6 Clean only with dry cloth.
- 7 Do not block any ventilation openings. Install in accordance with the manufacturer's instructions.
- 8 Do not install near any heat sources such as radiators, heat registers, stoves, or other apparatus (including amplifiers) that produce heat.
- 9 Do not defeat the safety purpose of the polarized or grounding-type plug. A polarized plug has two blades with one wider than the other. A grounding type plug has two blades and a third grounding prong. The wide blade or the third prong are provided for your safety. If the provided plug does not fit into your outlet, consult an electrician for replacement of the obsolete outlet.
- 10 Protect the power cord from being walked on or pinched particularly at plugs, convenience receptacles, and the point where they exit from the apparatus.
- 11 Only use attachments/accessories specified by the manufacturer.
- 12 Unplug this apparatus during lightning storms or when unused for long periods of time.
 Use only with the cart, stand, tripod, bracket, or table specified by the manufacturer, or sold with the apparatus. When a cart is used, use caution when moving the cart/apparatus combination to avoid injury from tip-over.
- 13 Refer all servicing to qualified service personnel. Servicing is required when the apparatus has been damaged in any way, such as power-supply cord or plug is damaged, liquid has been spilled or objects have fallen into the apparatus, the apparatus has been exposed to rain or moisture, does not operate normally, or has been dropped.

Warning!

- To reduce the risk of fire or electrical shock, do not expose this equipment to dripping or splashing and ensure that no objects filled with liquids, such as vases, are placed on the equipment.
- This apparatus must be earthed.
- Use a three wire grounding type line cord like the one supplied with the product.
- Be advised that different operating voltages require the use of different types of line cord and attachment plugs.
- Check the voltage in your area and use the correct type. See table below:

Voltage	Line plug according to standard
110-125V	UL817 and CSA C22.2 no 42.
220-230V	CEE 7 page VII, SR section 107-2-D1/IEC 83 page C4.
240V	BS 1363 of 1984. Specification for 13A fused plugs and switched and unswitched socket outlets.

- This equipment should be installed near the socket outlet and disconnection of the device should be easily accessible.
- To completely disconnect from AC mains, disconnect the power supply cord from the AC receptable.
- The mains plug of the power supply shall remain readily operable.
- Do not install in a confined space.
- Do not open the unit - risk of electric shock inside.

Caution:

You are cautioned that any change or modifications not expressly approved in this manual could void your authority to operate this equipment.

Service

- There are no user-serviceable parts inside.
- All service must be performed by qualified personnel.

IMPORTANT SAFETY INSTRUCTIONS

EMC / EMI.

This equipment has been tested and found to comply with the limits for a Class B Digital device, pursuant to part 15 of the FCC rules.

These limits are designed to provide reasonable protection against harmful interference in residential installations. This equipment generates, uses and can radiate radio frequency energy and, if not installed and used in accordance with the instructions, may cause harmful interference to radio communications. However, there is no guarantee that interference will not occur in a particular installation. If this equipment does cause harmful interference to radio or television reception, which can be determined by turning the equipment off and on. The user is encouraged to try to correct the interference by one or more of the following measures:

- Reorient or relocate the receiving antenna.
- Increase the separation between the equipment and receiver.
- Connect the equipment into an outlet on a circuit different from that to which the receiver is connected.
- Consult the dealer or an experienced radio/TV technician for help.

For the customers in Canada:

This Class B digital apparatus complies with Canadian ICES-003.

Cet appareil numérique de la classe B est conforme à la norme NMB-003 du Canada.

Certificate Of Conformity

TC Electronic A/S, Sindalsvej 34, 8240 Risskov, Denmark, hereby declares on own responsibility that following product:

G-Force - Guitar Effects Processor

That is covered by this certificate and marked with CE-label conforms with following standards:

EN 60065 (IEC 60065)	Safety requirements for mains operated electronic and related apparatus for household and similar general use
EN 55103-1	Product family standard for audio, video, audio-visual and entertainment lighting control apparatus for professional use. Part 1: Emission.
EN 55103-2	Product family standard for audio, video, audio-visual and entertainment lighting control apparatus for professional use. Part 2: Immunity.

With reference to regulations in following directives:
73/23/EEC, 89/336/EEC

Issued in Risskov, May 1997

*Anders Fauerskov
Managing Director*

TABLE OF CONTENTS

WELCOME	<i>About this Manual</i>	5
FROM THE USERS POINT OF VIEW	<i>Foreword by Palle Schultz</i>	6
QUICK REFERENCE	<i>Buttons, Knobs, Controllers and other functions</i>	7
THE FRONT PANEL		8
THE REAR PANEL	<i>Inputs, Outputs</i>	10
THE SIGNAL FLOW		11
HOW TO...	<i>build a User Preset, connect the Modifiers, setup an Expression Pedal etc.</i>	12
SETUPS		16
RECALL	<i>Recalling a Preset, Factory/User presets, Memory card</i>	17
STORE	<i>Store a new preset, The Letterbox</i>	18
EFFECTS		29
I/O MENU	<i>I/O, Input selector, Sample Rate, Mix, MIDI setup</i>	21
MODIFIERS		25
UTILITY	<i>System parameters, Billboard settings</i>	29
TEMPO		31
TUNER		32
THE BLOCKS		33
THE RESET PAGE		48
TECHNICAL SPECIFICATIONS		49
TROUBLE SHOOTING		50
MIDI IMPLEMENTATION CHART		51
SELF TEST		52
PRESET LIST		54

WELCOME

Congratulations

Congratulations on the purchase of your new G-Force. We hope that you have as much pleasure using it as we had making it.

The G-Force is carefully designed to produce the ultimate guitar effects. To achieve this, we supplied you with eight un-compromised, simultaneous effects. This means that the G-Force has the power to run all eight effects without losing sound quality. You can route the effect blocks in any combination you like, and the 24 bit resolution converters make it possible to run your guitar straight through without a line-mixer, while preserving your original guitar tone. Check out the Modifier Matrix and discover a powerful tool for real-time external and internal control of the many parameters of the G-Force.

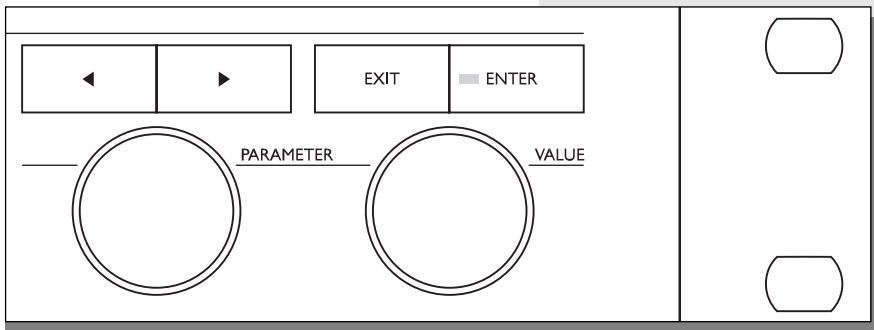

About this Manual

Many people in the music business (and elsewhere) have an aversion to reading manuals. We understand that. So if you feel like starting without reading the whole manual, simply get going. You can always use the manual for checking out areas that you have questions about, or if you want to dig deeper into the unit. Refer to the Table of Contents for further information.

On the other hand, you might want to know a little more about the G-Force before you start pressing keys. The manual will take you step by step through all of the G-Force functions. If you want to read about a specific function, please refer to the Table of Contents.

FROM A USERS POINT OF VIEW

Foreword by Palle Schultz, a guitar player with 10 years experience.

From a users point of view

If you ditch your beloved stomp boxes and invest your money in a multi-effects unit, you'll most likely lose the simplicity and flexibility of your pedal arrangement. You'll often have to deal with phone book sized manuals and interfaces made by and for computer experts.

These circumstances often drive creative people and musicians away from such space-age machinery.

I've owned several different effect units, that each had their own version of a hostile user interface so I've been waiting a long time for someone to develop a multi-effect that doesn't clash with ones creative state of mind. The fact that those "someone" are the people of TC Electronic guarantees the quality of the entire product.

The G-FORCE is a very flexible machine which is very easy to approach. You have the choice of simply using it as a linear chain of effects or you can go beyond the use of any known multi-effect unit, and explore the countless combinations and control possibilities within the G-FORCE.

After a short while of using the G-Force, I changed my whole approach towards the creation of effects for my guitar. From simple use of standard effects like delay, chorus and reverb connected in a straight line, I now find myself thinking up a non-existing effect like say; a tremolo that only kicks in when you play on the high notes, while the level of a phased distorted dark delay is controlled by your old volume pedal that you calibrated for use with your G-FORCE.

If you are totally new to digital machinery like the G-FORCE, and are a hard-core knob turner but get frustrated dealing with scroll bars, LCD-displays and strange technical terms, then you have ended up buying the right product. The TC Electronic G-FORCE is so easy to use that it's a bit ridiculous that this manual even exists. When you cruise around the G-FORCE, and want a certain thing to happen and have a feeling that this particular parameter is the right one to adjust, then you're most probably right. The way you learn this machine is by using it, don't be afraid of tweaking anything to its maximum, the edges are the learning spot and from there you either take a fall or a step back. The cool thing about the G-FORCE is that you won't hurt yourself, if you go over the edge, but you might end up with the strangest or coolest new effect you ever heard.

One very pleasing side effect of owning a G-FORCE is the dramatically lighter rack you'll end up with. Mine certainly slimmed down to a tiny Formula One sized powerhouse.

Palle Schultz

QUICK REFERENCE

General Control

General control of the G-Force is accomplished by dialing the Parameter wheel to change parameters, and the Value wheel to change values. In many of the displays you can select different menus by pressing the < > Arrow keys e.g., in the Effects display you can select between Mix, Edit, Routing and Layout. Press Enter to carry out an action (for example, when recalling a preset).

Recall

Press Recall (if you are not already there). Be sure that the cursor is placed on "Preset", and dial the Value wheel to scroll through the presets. Press Enter to load the new preset.

Quick Store

If you want to store a preset with the same name, press Store to access the Store menu, and press Enter to confirm. The G-Force will now automatically store your preset in the first free User space, using the current name. When you try to restore an existing User preset, the G-Force will default to the same User preset number.

Editing

Press Effects and select the Edit display using the < > Arrow keys. Double click the bypass key of the block you want to edit.

Setting up your MIDI board

Press I/O Setup and select MIDI using the < > Arrow keys. Adjust the MIDI basic channel so it matches the one of your foot controller. Be sure that Program Change is enabled. Your foot controller should now be able to change presets on the G-Force. If you want to recall User presets via MIDI, scroll down to Mapping Mode and select "into User bank" by turning the Value wheel.

Setting up an Expression Pedal

Connect your pedal with a mono guitar cable to the External Control In. Press I/O Setup and select Control using the < > Arrow keys.

In this list there are a number of things that can be controlled by an Expression pedal. Let's set up control of the Main volume. Place the cursor on "Main Vol" - Press Enter (for Learning) and move your pedal. The G-Force will now automatically detect your pedal. The functions of Ext. 1-8 are set up in the Modifiers Matrix.

Input/Output

Use the Input/Output knobs in the upper left corner of the front panel to adjust the levels of the G-Force. If you are using the G-Force in a mono setup, you should select L-only in the I/O setup, Audio menu. This menu will also provide I/O gain information.

The Killdry function should be On if you are using the G-Force in a parallel setup i.e. in combination with a line mixer.

THE FRONT PANEL

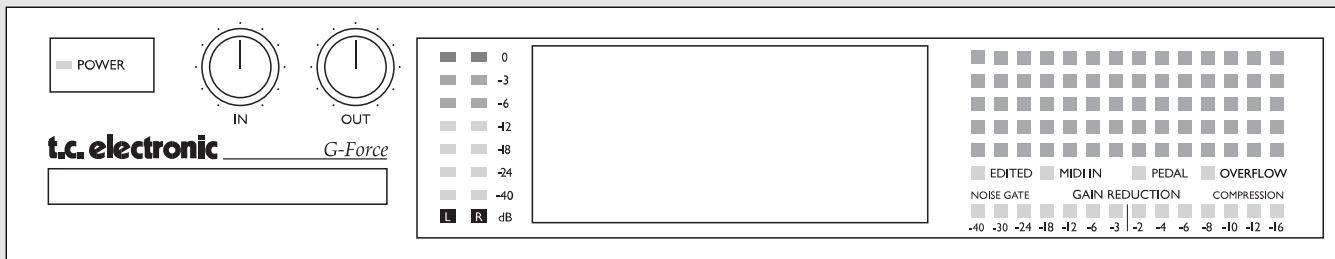

POWER

Press and hold the Power switch for about 3 seconds, then release to power off.

IN/OUT KNOBS

The overall Input level is adjusted via the knob in the upper left corner of the G-Force. The Input should average approx. -3 to -6 dB on the Input meters. Set your output level using the Output knob.

CARD SLOT

The PCMCIA slot can be used for storing and loading presets. Use Type 1 PC Cards with a minimum 64 KBytes of SRAM.

METERS

These meters indicate the level of Left and Right inputs.

The Input level of the G-Force automatically optimizes the signal to noise ratio via a small relay in the input section. You will see a prompt on the display and may hear a small click when the input gain range is changed.

BILLBOARD

The Billboard of the G-Force is capable of showing preset number and name, Tempo and a global message that you can write into the G-Force (refer to Billboard in the Utility section). Both Tuner and Tempo use the Billboard to display information as well.

Beneath the Billboard you will find four indicators, displaying: Preset Edited, incoming MIDI information, incoming Pedal information and internal Overflow. The two lower meters will indicate gain reduction in the Compressor and Noise Gate, but are also used as tuner indicators when Tuner is active.

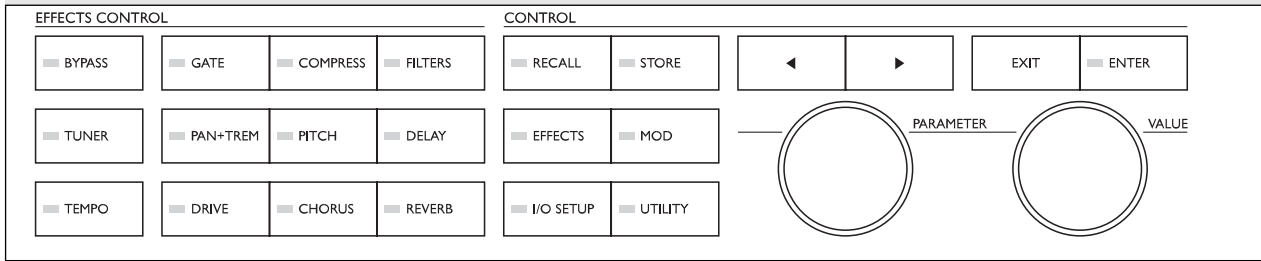

OVERALL BYPASS

The Bypass key in the upper left corner is the overall bypass. With this key you can bypass all effects in the G-Force simultaneously.
Note: If the Killdry function (in the I/O Setup Audio menu) is active, the G-Force will be muted. This means that no sound will pass through.

TUNER

Press this key to enter Tuner mode.

TEMPO

Tap the global tempo using the Tempo key. *Note: this may affect the current preset. Pressing the Tempo key will enable the Tempo pop-up menu. This menu will disappear after a few seconds. The Tempo key will indicate the global tempo by blinking.*

EFFECT BYPASS

The nine effect keys are dedicated to bypassing any of the eight effects and the Noise Gate. These keys can bypass an effect block at any time, no matter what display you are working in. When you are in the Effects Edit display, double click for fast access to the Edit parameter menu

ARROW KEYS

In many of the displays you can select different menus by pressing the Arrow keys, i.e. in the Effects display you can select between Mix, Edit, Routing, and Layout.

THE PARAMETER WHEEL

Use the Parameter wheel to change position of the cursor in the display

THE VALUE WHEEL

Use the Value wheel to change the values of a parameter.

ENTER, EXIT

The Enter key is used to confirm actions, or for accessing into a block. The Enter key will blink when the G-Force needs you to confirm. The Exit key is normally used to exit a menu, or to cancel an action.

THE REAR PANEL

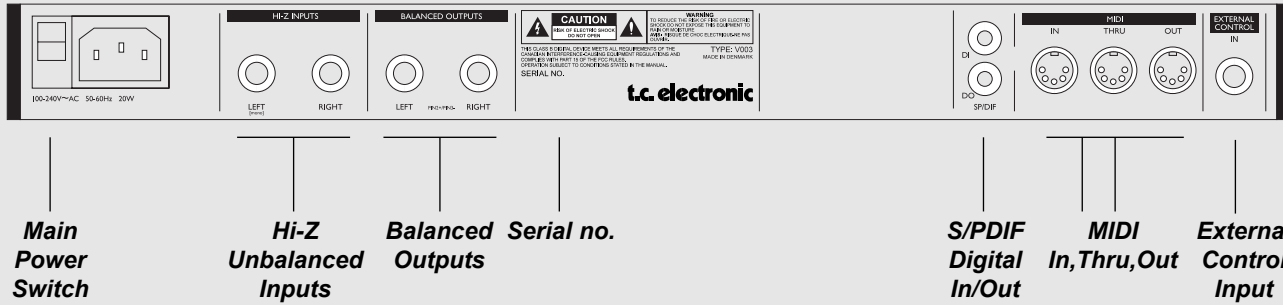

Notes:

The G-Force Input jacks are unbalanced. The Output jacks are balanced.
If you are connecting the Outputs via stereo jacks to unbalanced equipment, you must tie ring and sleeve together in the cable ends away from the G-Force.

You can always use standard mono guitar cables to connect G-Force.

External control input can use momentary, alternating and continuous type pedals.

The G-Force power supply is capable of operating at any line voltage from 100-240 Volts, 50-60Hz.

THE SIGNAL FLOW

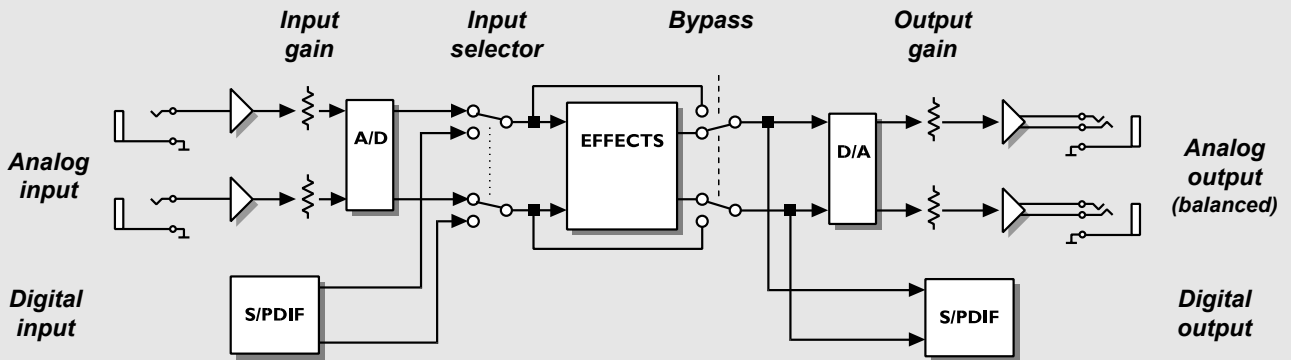

Notes regarding the signal flow:

Signal is always present at both the Analog and Digital outputs.

G-Force is limited to 44.1kHz sample rate at both Analog and Digital inputs.

The Input level of the G-Force automatically optimizes the signal to noise ratio via a small relay in the input section. You will see a prompt on the display and may hear a small click when the input gain range is changed.

How to build a User preset

This is a step by step guide to some of the main functions used when building your own presets.

Start by Recalling factory preset #225 called "Empty Routing":

- Press Recall.
- Dial the Value wheel until you see preset 225.
- Press Enter to recall the current preset.

Setting up an Effect

There are two ways of inserting an effect. Let's start by setting up a Reverb.

- Press the Effects key.
- Use the < > Arrow keys to select the Routing display.
- Use the Parameter wheel to place the cursor in the third position of the first column.
- Double click on the Reverb bypass key to insert the Reverb.

And the other way:

- Press the Effects key.
- Use the < > Arrow keys to select the Routing display.
- Dial the Value wheel until you see "REV" and press Enter to insert the Reverb in the Routing.

Editing an effect

There are two ways of getting into the Edit parameter display. Here is the first and easiest - after pressing the

Effects key:

- Use the < > Arrow keys to access the Edit display.
- Double click on the Reverb bypass key.
- Use the Parameter wheel to scroll up and down, and the Value wheel to change values.

And the other way - after pressing the Effects key:

- Use the < > Arrow keys to access the Edit display.
- Dial the Parameter wheel to move the cursor to the Reverb block.
- Press Enter to access the Edit parameter display.
- Use the Parameter wheel to scroll up and down, and the Value wheel to change values.
- Press Exit to leave the Edit parameter display or double click the Reverb bypass key again.



If you want to Edit another effect you can just double click the current block bypass key right away, and the G-Force will exit the first and then open the second.

How to set the level of a preset:

There are a couple of different ways to set the level of a preset, but in any case you should consider reserving a bit of headroom for the preset you want to be the loudest. One method is to lower the Input (or Output) level of the last block in the routing. That means that if you have blocks in a parallel combination, you will have to change the level equally to keep the same relationship between the current effects.

Another way is to use the Level in the In section. That particular level is placed after the Noise Gate but before anything else. This In Level is also present in the Modifier Matrix which means that you can control it via an expression pedal.

How to add a block to the Routing

Now we have a Reverb, but we would like a Delay as well. You need to decide whether you want the Delay in parallel or series as opposed to the Reverb. Let's try parallel, from the Routing menu:

- Place the cursor in the second position, first column, using the Parameter wheel.
- Double click on the Delay bypass key to insert the Delay block.

If you run blocks in parallel, you should consider your mix strategy. It may be wise to run all effects but one at 100% mix and use the In/Out level to balance the level of the effects relative to each other.

How to change a sub-algorithm

The Delay that you just inserted is a Stereo Delay that uses the same delay time in both left and right channels. Let's try to find a delay with different times in left and right:

- Move the cursor to the Delay block using the parameter wheel.
- Press Enter to dive into the Edit parameter display.
- Use the < Arrow left key to step to the sub-algo list.
- Dial the cursor to "Dual" using the Parameter wheel and press Enter to change the sub-algorithm.

You now have a Dual delay algorithm, where you are able to set different delay times in left and right channels (remember to set the panning of the two delay times).

Moving all blocks using the Layout

It suddenly comes to my mind that we need a Compressor in front of the Delay and Reverb. Let's try to move the Delay and Reverb block:

- Press the > Arrow right to move to the Layout display.
- Dial the Value wheel to "Move R".
- Dial the Parameter wheel fully counter clockwise and press Enter to move the two blocks to the right.
- Press the < Arrow left key once to select the Routing display.
- Place the cursor in the second position, first column and double click the Compressor bypass key. There you go, a Compressor in front of the Delay and Reverb blocks.

How to Delete or Replace a block

If you want to remove a block from a routing or just want to replace it e.g. change the Reverb into a Chorus, here is what you do:

- Press the Effects key.
- Press > Arrow right key to access the Routing display.
- Move the cursor to the block you want to remove, using the Parameter wheel.
- Dial the Value wheel counter clockwise until the block is black or until you see the new block you want, and press Enter. You could also just double click on the desired block.

The Block is now removed or replaced.

How to Store your new preset

Now that we built a preset with Compressor, Delay and Reverb, it is time to Store. You can store very quickly using the same name or Store with a new name. This is the fast way:

- Press the Store key.
- Dial the Value wheel to select a storing space (G-Force defaults to the first empty User preset).
- Press Enter to Store with the same name.

Here is what you should do after you found the right storing space, if you want to it store with a new name:

- Dial the Parameter wheel to the name line.
- Dial the Value wheel and press Enter to select a letter.
- When you finish the name, go to "Done" using the Value wheel and press Enter to Store.

How to obtain spillover at preset change

Spillover from one preset to another can be obtained by using the same sub-algorithm and the right Mute mode in two following presets.

Example: You want the tail Delay from one preset to ring out when you change to a none Delay preset, here is what you do:

- Enter the Edit Parameter display of the Delay in the first preset.
- Scroll down to "Mute mode" and select "FX In".
- Store that as preset 1.
- Use the exact same Delay setting and Mute mode in the next preset, but bypass the Delay block.
- Store that as preset 2.

You are now able to change from preset 1 to preset 2 with the Delay ringing out.

How to connect the Modifiers

The G-Force has a number of extra internal modifiers that can create extra functions and make your presets play along with you, e.g. Envelope follower, ADSR, Pitch detector, etc. Here are a couple of examples and how to set them up. The starting point is the preset we just built in the above, or ROM preset #21.

Creating a ducking Delay

Right now you have a constant level of Delay, wouldn't it be nice if the Delay only popped up in pauses where you do not play. Let's try that:

- Press the Mod key to select the Matrix display.
- Scroll horizontal using the Value wheel until you see "ENV" (Envelope) in the top line.
- Scroll vertical using the Parameter wheel until you hit the point where "ENV" and Delay Outlevel meets.
- Press Enter to link the two parameters.

Now you will hear the Delay follow the level of the Input, i.e. when you play, the Delay plays. But it would be more usable if the Delay played when you didn't play, so let's do that:

- Place the cursor on the connection spot (if it is not already there) and press Enter to dive into the link display.

HOW TO

- Change the curve by setting the three input parameters. If you want the Delay to stay down while you play, Low input should be 100%, and High input should be 0%. Experiment with these values.

Press Exit to leave the Link display. If you want remove the link simply press Exit again.



If you want to remove all links of the Matrix, press Exit twice and you will see a pop up box asking you to confirm with Enter or abort with Exit.

Creating an Autopanning Delay via Modifiers

If you want the Delays to autopan you could of course, place the Pan/Tremolo block after the Delay, but you can also use one of the extra LFO's that are in the Modifier Matrix.

- Press the Mod key to select the Matrix.
- Connect the LFO1 output 1 to Delay Pan 1 and Pan 2 by pressing the Enter key.
- Press > Arrow right key to enter the Modifiers display, scroll down to LFO1 and press Enter to dive into the settings of the LFO1.
- Set the Speed, Depth, Curve etc. of LFO1 and listen to your Delay Panning.

Right now the two Delays are panning left and right together, but it would be nice if they panned opposite of each other.

- Press Exit to leave the LFO edit display.
- Press the left < Arrow key to get back to the Matrix display.
- Scroll down to the connection between LFO1 and Delay Pan1 and press Enter to access the link display.
- Change Low input to 100%, and High Input to 0%.

Your delays are now panning opposite of each other.

How to set up an Expression pedal

The G-Force has several control possibilities that can make your presets a lot more flexible and interesting. These functions can be realtime controlled by more than eight external pedals or MIDI controllers.

Connecting

Your Expression pedal can be connected in two ways, either directly to the "External control" jack on the back panel of the G-Force, or via a MIDI board.

How to calibrate and choose Pedal type

The G-Force can be controlled by various types of pedals. The type of pedal that you are using is set up in the Utility display, by the "Pedal type" parameter. When you are using Expression pedals, you should select "Alternating".

When you connect your expression pedal to the "External control" jack, you should make sure that the G-Force is calibrated for that particular pedal. That is done in the Utility display:

- Press Utility.
- Scroll down to "Pedal calibration", using the Parameter wheel.
- Press Enter and follow the instructions in the display.

You have now calibrated your expression pedal, and are ready to setup the function of it.

The function of the Pedal

The basic idea is that your pedal should be connected to one of the eight virtual handles called Ext1-8. That is done in the I/O Setup, Control display:

- Press the I/O Setup key.
- Press the > Arrow right key to select the Control display.
- Scroll down to "Ext1" using the Parameter wheel.
- Press Enter to activate the Learn function and move your pedal to get it detected.

Your pedal should now be detected whether using the 1/4" jack on the back panel of the G-Force, or a MIDI controller. The pedal could also control the Main volume, the overall bypass, the Tuner, the Tempo or one of the other seven external controllers.

Now that you have your pedal setup for Ext1, we will move on to getting it connected to a parameter:

- Recall ROM preset #17 "Stereo Harmony C-maj". That is a preset that will add a third, and a fifth to your lead play as long as you stay in C-major.
- Press the Mod key to access the Modifier Matrix.

HOW TO

- Scroll horizontal until you see Ext1 in the top line of the display, using the Value wheel.
- Scroll vertically using the Parameter wheel until the cursor is placed on the line where Pitch "In level" and "Ext1" meet.
- Press Enter to connect the two parameters.

You now have your pedal connected to the In level of the Pitcher, which means that you can control the amount of pitch with your foot. The function of the pedal is stored with the preset.

A lot of the ROM presets are setup for various pedal functions, they are all using Ext1 as Modifier.

How to set up my MIDI board

The G-Force is capable of using a lot of the existing boards on the market for standard program change. Here is what you do to set your board up with the G-Force:

- Connect your board to the MIDI In socket on the back panel of the G-Force.
- Press the I/O Setup key.
- Use the < > Arrow keys to select the MIDI display.
- Set the "Basic channel" to the same as your MIDI board.

Your board is now be able to change ROM presets on the G-Force.

How to change User presets using my MIDI board

If you want to change User presets in the G-Force via your board this is what you should do:

- Enter the I/O Setup, MIDI display again.
- Scroll down to "Mapping mode" using the Parameter wheel.
- Select "Into User bank" using the Value wheel.

Your board should now be able to change the User presets (given that you made some) of the G-Force.

How to use some of the extra functions of my board with the G-Force

A lot of boards on the market have the possibility of performing MIDI on/off functions, MIDI bypass etc. The G-Force has a list of board defaults that makes it possible to setup these boards really fast. These are the boards in the list:

ADA MXC
ART X-15 Ultrafoot

DMC Ground Control
Rocktron All Access
Roland FC-200
Custom Audio Electronics RS-10
TC Electronic G Minor
Lexicon MXP R1

If you own one of these boards here is what to do to set it up:

- Enter the I/O Setup, Control display.
- Scroll down to "Model" using the Parameter wheel.
- Select your board and press Enter to load the settings.

The G-Force is now setup to respond to the default settings of the current board.

If your board is not in the list, here is what to do to setup some of extra functions anyway:

- Enter the I/O Setup, Control display.
- Scroll down to the function you want to control.
- Press Enter to activate the Learn function.
- Press the switch or pedal you want to use for the current function.

You can perform this Learn function on all the parameters in the Control display.

How to Recall a single block from an existing preset

The G-Force have a possibility of Recalling a single block from one preset into another. Try to Recall ROM preset # 23, called "Stereo Touchwah". Now we will Recall the Filter block from ROM preset # 12, called "Mono Farout Phaser".

- Press Recall.
- Dial the Parameter wheel to place the cursor on "Select".
- Dial the Value wheel until the matrix cursor is placed on "FIL".
- Move the cursor back to "Preset" using the Parameter wheel.
- Select preset 12 and press Enter to load the Filter block into the current Routing.

The Filter block of preset 12 is now loaded into preset 23. This partial Recall function can of course Recall blocks from ROM, User and Card presets.

SETUPS

G-Force Setup

The G-Force is carefully designed to perform all the basic effects needed in a guitar setup.

Because the G-Force can be used in a number of applications we propose a few different setups.

Be sure that your amplifiers are turned off while connecting the G-Force. Turn on the G-Force before your amplifiers.

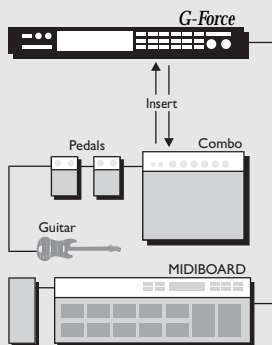

The Mono Guitar System

In a setup with a Combo amp or a mono stack you must use the Left input and output (remember to select L-only, in the I/O Setup Audio display) You can either place the

G-Force in the effect loop or after the pre-amp, (this could also mean after your Distortion stomp box).

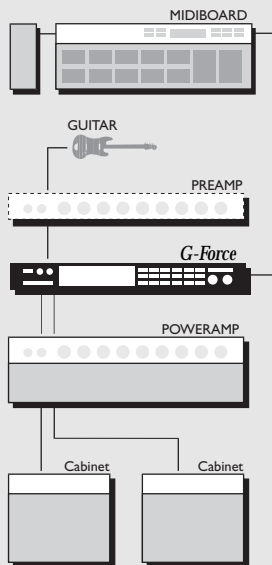

The Stereo Guitar System

In a setup with a couple of Combo amps or a stereo stack, you get full advantage of the stereo effects in the G-Force. Place the G-Force after your pre-amp or in the effect loops.

Serial setup

This is the ultimate setup for the G-Force. The high quality 24 bit converters makes it possible to use the G-Force without a line mixer. The serial setup utilizes the power of the G-Force to its full extent. Remember, the G-Force gives you the possibility to make the effect blocks parallel internally.

Parallel setup

Using the G-Force in combination with a line mixer. Remember to use the killdry function, to avoid any direct guitar signal through the G-Force.

The Connections

The G-Force input jacks are unbalanced and the outputs are balanced. This means that you can use standard guitar cables to connect the G-Force to unbalanced equipment, and stereo cables to connect the G-Force to balanced equipment.

Input/Output

Set the Input level of the G-Force using the In knob in the upper left corner of the front panel. To get maximum quality from the 24 bit AD converter, the input meter should show approximately -6 to -3 dB. Adjust the output level of the G-Force using the Output knob. In addition to the Output knob there is a MIDI/Pedal controllable master level placed in the Out section (Effects Edit display).

The Recall Display

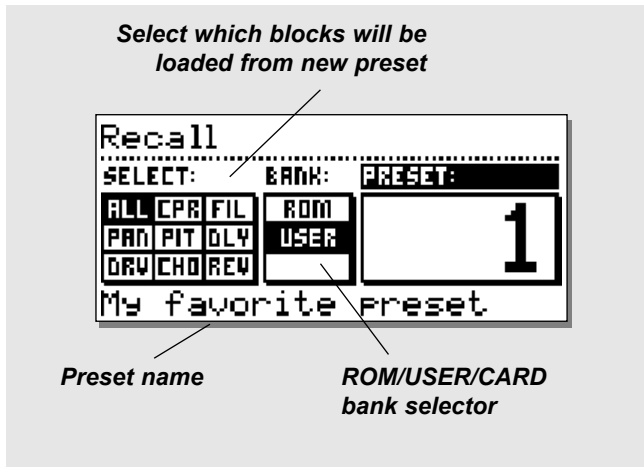

General

Select section

Is used to point to a certain block that you want to recall alone. Should be set to "All" when you want to recall a complete preset. (default setting)

Bank

Is used to select which bank you would like to recall from, ROM (factory presets), User, or Card (only available when a pc-card is inserted).

Preset

Dial the Value wheel to preview the presets. Press ENTER to recall.

Recalling a Preset

- Set cursor at "Bank" section using the PARAMETER wheel.
- Select which bank to recall from using the VALUE wheel.
- Select "Preset" section using the PARAMETER wheel (see illustration above)
- Select which preset to recall using the PARAMETER wheel.
- Press ENTER.

Preserving the tail of Reverbs and Delays at preset change

Spillover from one preset to another can be obtained by using the same sub-algorithm, and combination of Mute mode = "Fx In" and bypassing the current block. Example: If you want to leave a Delay tail hanging over a preset change, you must be sure to keep the same sub-algorithm in both presets. In addition to that you should select the "Fx In" Mute mode and just bypass the Delay block in the second preset.

NOTE: Changing parameters like the Feedback or Mix over a preset change can kill the Delay.

Optimal preset change

Since the change from one preset to another can contain drastic changes in level and Routing, artifacts may occur if the preset is changed while playing.

To obtain the best preset change while playing, you should keep Routings as even as possible.

Example: When changing from a preset containing Reverb and Delay, to a preset containing only Reverb you should just bypass the Delay block instead of removing it (that will also enable you to obtain spillover from the Delay block)

Recalling a single effect

It is possible to load a single effect setting into an existing Routing, e.g. if you are building a new preset and have come up with a really nice Reverb and Delay but would like to add that Chorus sound you designed last week. Here is what you do:

Press Recall, and move the cursor to the Select parameter using the Parameter wheel.

Now use the Value wheel to point to "CHO" (Chorus). Move the cursor back to the Preset parameter and use the Value wheel to scroll through the presets (remember to set the bank, you wish to Recall from).

NOTE: the G-Force will now scroll through only presets containing the desired effect.

Press Enter to Recall the desired effect. The G-Force will now update your current preset with the new effect, and return to the current preset.

STORE

Store a new User preset

- Press the Store key.
- Select a location for your new preset. (the G-Force can hold 100 User presets).
- Move the cursor to the new name line and dial in the new Preset name (find letter or number with the Value wheel and confirm with the Enter key).
- Set Cursor to DONE and press Enter to complete the store operation.

Quick Store with the same name

If you want to store an edited Factory preset with the same name, simply press Store and Enter. The G-Force will automatically store the preset in the first empty User space.

If you want to store an edited User preset with the same name, simply press Store and Enter. The G-Force will suggest the same User preset position as the storing space.



The Letterbox

When you want to change the name of the preset to Store, dial the Parameter wheel. You are now able to write a new name using the Letterbox. Simply dial the Value wheel and press Enter to select new letters or numbers.

Select CAP, by pressing Enter, to change the letter case. When you have changed the name, select DONE in the Letterbox and press Enter to Store.

Press any key to leave the Store display.

Using a Memory Card

When inserting a memory card you gain access to the card banks. The card banks are located immediately after the User bank.

Depending on the size of the card you can store up to 9 banks of 100 user presets.

Card types

S-RAM Type 1 PCMCIA cards, with a minimum of 64Kbytes, and a maximum of 2Mbytes S-RAM.

Delete

Use the < > Arrow keys to select Delete. Dial the Value wheel to select the preset you want deleted, and press Enter to delete.

EFFECTS

Double click on the block bypass key of the effect you want to edit

Select In and press Enter to edit Noise Gate

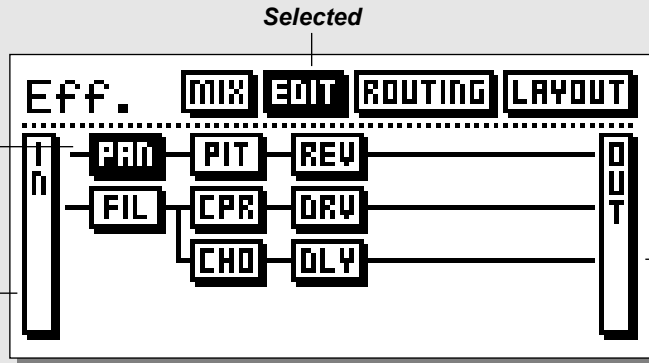

Select Out and press Enter to edit Speaker filters

Double click on the block bypass key of the effect you want to insert or dial Value wheel to find new effect and press Enter to insert.

Empty spaces

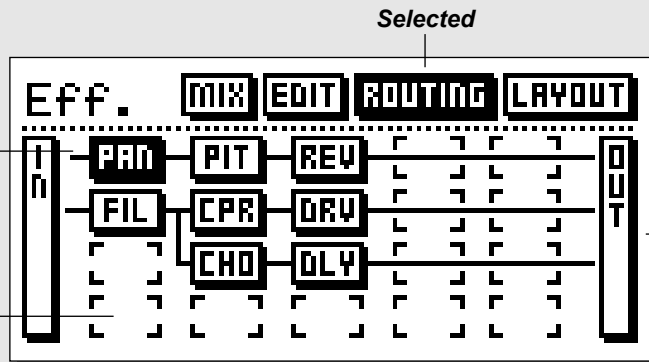

Dial Parameter wheel to select effect and press Enter to edit right away.

Set mix in each block

Set In Level in each block

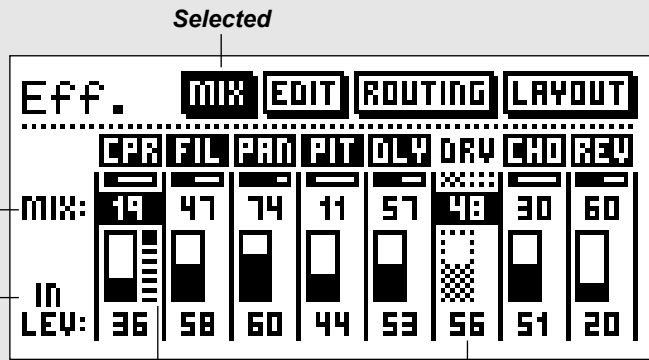

Input meter of each block

Bypassed block

If you want to Edit one of the eight effects, press the Effects key. In the header of the effects display you can choose between - Mix, Edit, Routing, and Layout. By using the < > Arrow keys you can step between the four displays. If an effect is bypassed, it will appear with no bottom line.

Editing an effect

Press the Effects key and select the Edit display (using the < > Arrow keys). Double click on the block bypass key of the effect you want to edit, or point the cursor to the block you want to edit, and press Enter to access the Edit parameter display.

Note that you can also select the In and Out section, e.g. the Noise Gate is placed in the In-section.

When you are in the Edit parameter display, use the Parameter wheel to scroll through the parameters and the Value wheel to change values.

Press Exit or double click the block bypass key to leave the edit parameter display.



Double clicking another block bypass key will take you directly to edit parameter display of that particular effect.

Changing the Sub-algorithm

In each effect block you can choose between a couple of variations of the current effect, for example, in the Chorus block you can choose between Classic Chorus, Advanced Chorus, Classic Flanger and Advanced Flanger. To change the Sub-algorithm, you enter the Effect Edit parameter display and then use the < > Arrow keys to jump to the effect Sub-algorithm (upper left corner of the display). Now use the Parameter wheel to select the new Sub-algorithm and press Enter to confirm.

Routing

If you want to change the Routing or order of the effect blocks, use the < > Arrow keys to select the Routing display.

Use the Parameter wheel to select where you want to place an effect block, and double click the block bypass key of the effect you want to insert, or scroll through the effects using the Value wheel, and press Enter to choose the current effect.

If you simply want to lead the sound through a point, you select the pipeline icon.

The full Routing matrix is 4 high by 8 wide and you can place any effect (without duplication) anywhere in the matrix.

Editing directly from the Routing display

If you want to edit an effect right away, press Enter to access the Edit parameter display.

Use the Parameter wheel to scroll up and down, and the Value wheel to change values.

Press Exit to leave the Edit parameter display again.

Mix

In the Mix display, you are able to balance the mix and the In Level of the effects in that particular preset. If an effect is bypassed, it will appear as grayed out, however, you can still change the level and mix of that particular effect. A small PPM shows the input level of each block. When two signals are joined together there may be occasional overshoots. The meters of each block are therefore placed at the very input of the current block. This means that in case of overloads you should turn down the level of the previous blocks.

Use the Parameter wheel to scroll through the parameters and change values by dialing the Value wheel. Press Enter to activate the current effect or Exit to bypass it.

Layout

In addition to the Routing display, you have a couple of Layout tools. The Layout display can make certain actions very much easier. The functions of the Layout are very much like those of a spreadsheet.

In the Layout display, you see a miniature version of the Routing. By turning the Value wheel, you can change the cursor position. Now dial the Parameter wheel to select the desired function.

Column

Move L - Will move the current Column to the Left.

Move R - Will move the current Column to the Right.

Insert - Will insert a new Column.

Delete - Will delete the current Column.

Row

Move U - Will move the current Row up.

Move D - Will move the current Row down.

Insert - Will Insert a new Row.

Delete - Will delete the current Row.

Press Enter to carry out the selected function.

I/O SETUP

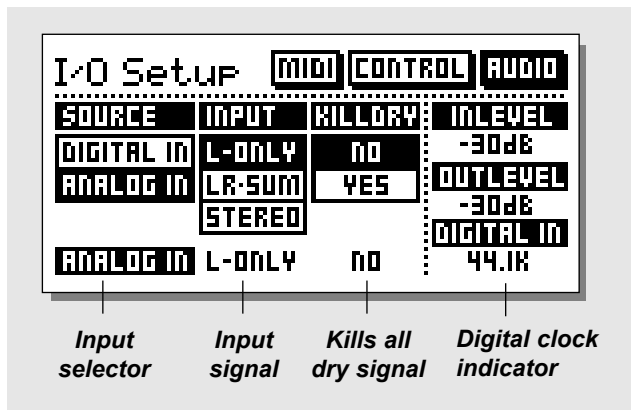

The parameters in the I/O Setup contain setups of all the G-Force's external connections: - MIDI, Pedal, Digital and Analog Audio. In the I/O Setup display, you can select between MIDI, Control and Audio using the < > Arrow keys. All settings of the I/O Setup are global, i.e. they do not change with the preset.

Audio

To set up the Audio In/Out parameters, press the I/O Setup key and use the < > Arrow keys to select Audio. The Source

With this parameter you can select between the Digital input of the G-Force, or the Analog input. G-Force is limited to 44.1kHz sample rate at both Analog and Digital inputs.

The Input

The G-Force can use the Left input only (mono), the sum of left and right input (LR-sum), or both left and right input (stereo). If you are only using one input on the G-Force, you should select L-Only.

If you want to input two mono sources, you can select LR-sum, this will enable both left and right to be summed together

Killdry

The Killdry function enables you to remove all dry (direct) signal in the G-Force. This function is very useful when you are running the G-Force in a parallel setup.

NOTE: When Killdry is active, the overall bypass key will work as a mute. Since you killed all of the dry signal and are bypassing the effect there is no output. The blocks will

preserve their internal relationships by keeping the mix level of the effect.

In Level, Out Level, Digital In

These are read-only parameters displaying the Input level (adjusted with the front panel controls), Output level (adjusted with the front panel controls), and the Digital input sample rate (shown only when you are using the digital input).

Note: The input level of the G-Force automatically optimizes the signal to noise ratio via a small relay in the input section. You may hear a small click from this relay when the input is being adjusted.

MIDI

In the MIDI section you set up the parameters of the global MIDI in the G-Force, meaning program change, MIDI mapping etc.

Basic Channel

The basic MIDI channel of the G-Force. This is the channel that you should transmit Prg. changes on to change presets in the G-Force.

Note: The G-Force's Modifiers are configured separately, meaning that they may refer to other MIDI channels.

Program change

With this parameter you set up how the G-Force should respond to incoming program changes. There are three possibilities:

Disabled - Will cause the G-Force to ignore any incoming program change. Preset Recall - Will enable the G-Force to use program changes sent on the "Basic channel".

+ Partial Recall - When this value is selected, the G-Force will still respond to program changes sent on the basic channel, but at the same time each of the eight effect blocks will have their own MIDI channels enabling you to recall a single block without affecting the rest of the preset. The channel numbers of the blocks are continuous from the Basic channel.

Example: If the basic channel is set to 1, the blocks channels will be Compress ch. 2, Filters ch. 3, Pan ch. 4 etc.

Bank Selection

This function is a new MIDI standard, making it possible to Recall presets above #128. The parameter determines whether the G-Force should respond to this message or

I/O SETUP

not. If your MIDI device or foot controller is capable of using this function, you should select Fine or Coarse. (Please refer to your MIDI device/Foot Controller owners manual to make sure which type the current product is using). If set to "disabled", the G-Force will act as a standard MIDI product.

Bank size

The bank size is used to adapt the G-Force to different board manufacturers when recalling preset above #128. In most cases this parameter should be set at 128, but in some cases e.g. when using the Roland FC-200, it should be set at 100.

The bank selection number contained in the program change is multiplied with this value and the program change number is added. Please refer to the manual of the board manufacturer for proper setting.

Sysex device ID

The Sysex ID of the G-Force.

Program change offset

With this parameter you are able to add or subtract to or from the incoming Prg. change; e.g. the incoming Prg. change is preset 123, and the offset is set to +1, the Prg. change will now be 124.

The G-Force presets start at #1.

Mapping mode

Adjusts which bank the MIDI mapping should use: ROM, USER, CARD or Custom. This means that you can guide an incoming Prg. change to use the USER bank, or you can design your own MIDI map.

New Mapping Mode

An "External" mapping mode has been added.

When External mapping mode is selected all presets in all banks can be accessed from an external MIDI device, via controller 0 (Coarse), plus a sent program change according to the following table. Bank Size must be set to 100 and the Fine/Coarse parameter must be set according to the sending device. These parameters are both set-up in the "I/O Setup - MIDI" menu.

Please note that "Coarse" must be selected when a G•Minor is used as sending device.

<u>Controller</u>	<u>Value</u>	
0	0	Rom bank preset 1 to 100
0	1	Rom bank preset 101 to 200
0	2	Rom bank preset 201 to 225
0	3	User bank preset 1 to 100
0	4	Card Bank 1 preset 1 to 100
0	5	Card Bank 2 preset 1 to 100
--	--	--
0	9	Card Bank 6 preset 1 to 99

The number of card banks available depends on the size of the PCMCIA card.

Custom Map

In the Custom Map you can decide what every incoming Prg. change should map to, using the "Map Program Change No." and the "Into Preset" parameters.

Map Program change no.

Use this parameter to select the Prg. change you want to remap.

Into Preset

Use this parameter to set the new destination of the incoming program change.

MIDI Program Change Re-Transmit

The G-Force is capable of controlling the re-transmission of an incoming MIDI prg. change. This enables you to not only remap an incoming program change, but also to determine whether the current program change should be re-transmitted to other devices receiving MIDI information from the G-Force MIDI Output or not.



A prg. change is re-transmitted on the G-Force MIDI Out connector, while the MIDI Thru connector transmits a copy of the signals received on MIDI In connector

Reset Custom Map

Place the cursor on this parameter and press Enter to Reset the Custom map.

Ext. Controllers

There are two ways to connect an expression pedal to the G-Force. One way is to connect it directly to the External Control jack on the back panel of the G-Force. The other way is to connect it via a foot-controller, i.e. as a MIDI controller.



To make it easy for you to set up a pedal, we designed a Learn function. Place the cursor on the parameter you want to control, press Enter to activate Learn, and press your pedal. The G-Force will now automatically detect your pedal, no matter if it is connected to MIDI or to the pedal jack.

In each of the following parameters, you can setup the input that the current parameter should be controlled by. In the first column you set up the source and in the second column you set up the type of the controller. Here is a description of the possibilities -

Column 1

- Pedal: The G-Force pedal input (see back panel).
MIDI basic: The parameter will respond to the basic G-Force MIDI channel (set in MIDI).
MIDI Omni: The current parameter will respond to all channels.
MIDI 1-16: The parameter will only respond to this channel.

Column 2

(please note that this column is only available when col.1 is set to MIDI).

- Pitch bend: Standard MIDI Pitch bend.
Aftertouch: Standard MIDI Aftertouch.
Note-on-key: Standard MIDI Note-on.
Controller 0-127: MIDI standard controllers.
Prg. Change: The Program Change feature is very special.

If a parameter is set to a certain Program Change, the current parameter will be toggled on/off by the current preset change.



If you are using a Program Change on the MIDI basic channel for controller purposes, the current Program Change will be ignored and will not perform a program change on the G-Force.

Setup bank

The G-Force has four banks which you can use for your different setups. By using the Value wheel, you can change the active bank from 1 through 4. The banks are instantaneously Stored and Recalled, meaning that any change you make in the Control menu is remembered in the current bank, and Recalled next time you select that particular bank. Each bank contains every parameter setting in the Control menu.

Board factory defaults

It is possible to set up the Control menu for a number of board defaults. Dial the Value wheel and confirm with the Enter key to load the board defaults. Only boards with MIDI On/Off or Expression possibilities are represented on the list. The complete list is:

ADA MXC	ART X-15 Ultrafoot
Roland FC-200	Rocktron All Access
DMC Ground Control	Lexicon MPX R1
Custom Audio Electronics RS-10	G Minor



This will change the whole Control setup to the defaults of the chosen board, meaning that it will override your settings.

G-Force control

- Main Vol.- Controls the main output volume of the G-Force.
Tempo - Use this parameter to tap the global tempo via MIDI or the G-Force pedal input.
Bypass - Controls the overall bypass of the G-Force.
Tuner - Use this parameter to activate the Tuner.

Modifier input

Ext. 1-8 - These eight inputs can control numerous parameters in the algorithms. Their functions are set up in the Modifier matrix display. These are the parameters you should set up to be controlled by your expression pedals.

Effect Bypass

The nine block bypass functions can be externally controlled via these inputs, meaning that you can bypass each of the nine effects independently. Some foot controllers on the market have the capability to send MIDI on/off messages for exactly this purpose. If you do not own a board with these features, you can use an ordinary program change to bypass a block, e.g. You can setup the Pan section to be bypassed when you send out program change #10 on MIDI channel 5.

How the Modifiers are connected

The basic flow of both the internal and external controllers is explained in this chapter.

In the G-Force you have a number of external controller inputs. These can be MIDI controllers, MIDI program change, the G-Force Ext. input 1/4" jack etc. These inputs must be connected to eight virtual handles named Ext. 1-8. The eight handles (Ext. 1-8) can be connected to a large number of algorithm parameters via the Modifier Matrix (see Matrix for further details). The point of the eight handles is that their connections are stored in the presets of the G-Force, meaning that you can use the same pedal for various purposes just by changing presets. These parameters status are not stored with the preset: Main vol. Bypass, Tempo and Tuner.

The G-Force also contains several extra internal Modifiers i.e. extra LFOs, ADRs, Envelope follower etc. These internal Modifiers are also present in the Modifier matrix, and can be connected to the same parameters as Ext. 1-8.

 The default setting of a Modifier connected parameter is equal to it's setting in the Edit parameter display.
Example: The Reverb mix level is set up to be controlled by a pedal, and the Mix parameter in the Edit parameter display is set to 15 %. When this preset is Recalled, the Reverb Mix will be 15%, and at first movement of the pedal, you will be in total control.

Setting up an Expression pedal

Example: You want to connect an expression pedal to the input level of the Delay block:

Connect your expression pedal to the G-Force external control jack on the back panel, and Recall a preset containing a Delay.

Press the I/O Setup key and select the Control display. Use the Parameter wheel to scroll down to the Modifier input section, and place the cursor on Ext. 1. Dial the Value wheel to select Pedal.

Now you have hooked up your expression pedal to one of the eight handles, so let's move on to connecting the handle to a parameter. Press the MOD key and use the < > Arrow keys to select the Matrix. Use the Value wheel to scroll horizontally, until you see Ext. 1 (your pedal) in the top line. Now use the Parameter wheel to scroll vertically until you see the Delay Inlevel. Press Enter to connect Ext. 1 to Delay In Level.

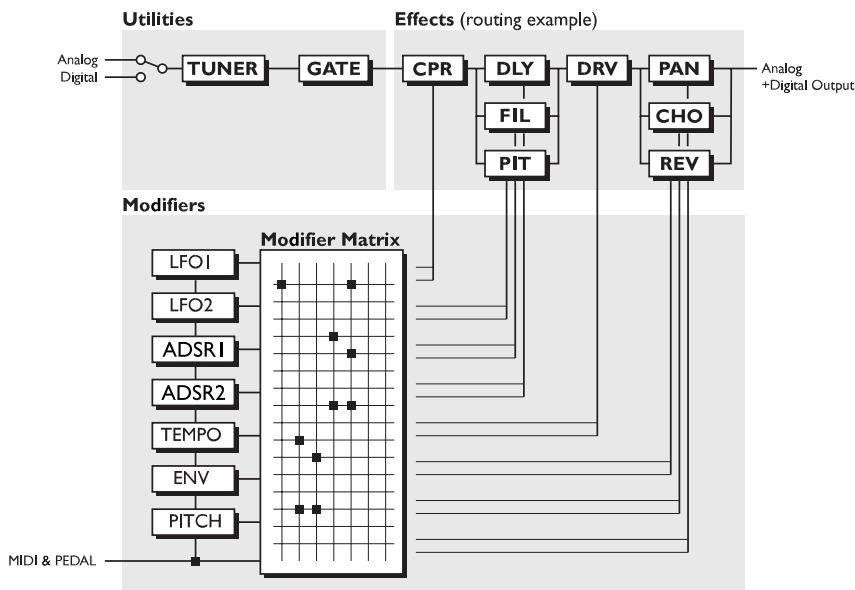

NOTE: If the parameter does not respond correctly, try to calibrate your pedal (see Utility, Pedal Calibration).

MODIFIER

Matrix

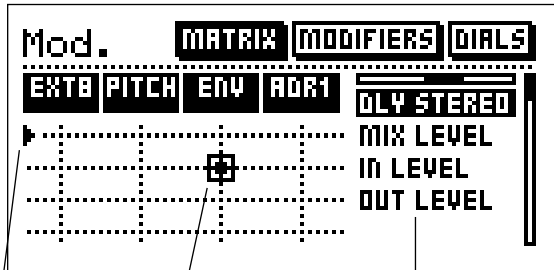

Cursor Connection Point Parameter List

The Matrix is where you connect your External pedals (set up in I/O Setup, Ext. Input) or the internal Modifiers to the parameters you want to control.

Dial the Parameter wheel to move the cursor vertically and the Value wheel to move the cursor horizontally. Press Enter to connect the two lines. Press Exit to remove a connection.

The basic concept is that you have a number of Modifiers (extra LFOs, ADSRs, ENV and your Ext. Inputs) in the top line of the Matrix. On the right hand side of the Matrix you have a list of the parameters available in the current preset. This means that an effect has to be present in the preset before it can appear in the parameter list.



Not all parameters in an effect are available. To connect a Modifier to a parameter, you move the cursor to the point where their two lines meet, and press Enter to connect them.

Example: You want LFO1 to modulate the speed of a Tremolo (be sure that the Tremolo is in the current preset). Now move the cursor horizontally by dialing the Value wheel until you have the cursor just below LFO1. Next step is to find the Tremolo speed. Dial the Parameter wheel until you hit the point where Tremolo speed and LFO1 intersect each other, now press Enter. The small dot indicates that the LFO and Tremolo speed are connected.

Link

When you have two lines connected, (i.e. Ext.1 connected to Tremolo speed) it is possible to make a transformation between the two lines. Move the cursor to the dot connecting the two lines and press Enter to enter the Link display.

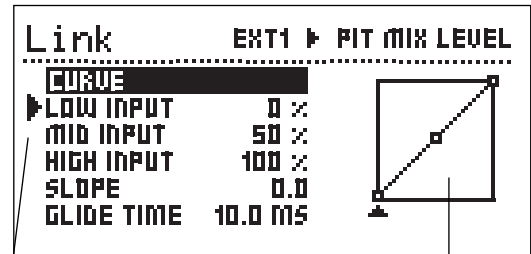

Cursor Slope

In the Link display, you can change the curve between the Modifier and the actual movement of the current parameter.

Low input

Use this parameter to adjust the minimum value of the modifier i.e. when your expression pedal is in the minimum position.

Mid input

Use this parameter to adjust the medium value of the modifier i.e. when your expression pedal is in the middle position.

High input

Use this parameter to adjust the maximum value of the modifier i.e. when your expression pedal is in the maximum position.

NOTE: These same transform parameters apply to the other modulation sources, for example Envelope, Low when the input signal into the G-Force is at its lowest and High when it is at its loudest.

Slope

Dial the Slope parameter to change the shape of the curve. Try it out and watch the curve change.

MODIFIER

Glide time

With this parameter you can set a minimum time that the parameter should use to go from maximum to minimum or vice versa, meaning that even though you move your expression pedal from min. to max. in a split second, the current parameter will still take some time to go through the same range.

Press Exit to leave the Link display.

Each modifier can be connected to several parameters at the same time but each parameter can have only one source.

The maximum number of connections that can be made on the matrix is 20.

Default parameter setting

The default setting of a Matrix connected parameter at Recall is equal to its setting in the Edit parameter display. Example: The Reverb mix level is set up to be controlled by a pedal, and the Mix parameter in the Edit parameter display is set to 15%. When this preset is Recalled, the Reverb Mix will be 15%, and at first movement of the pedal, you will be in total control of the parameter.



If you want to remove all links of the Matrix, press Exit twice and you will see a pop up box asking you to confirm with Enter or abort with Exit.

Modifiers

This is the display where you set up the parameters for the internal modifiers. Use the Parameter wheel to select the modifier you want to edit and press Enter to access the parameters of the current modifier.

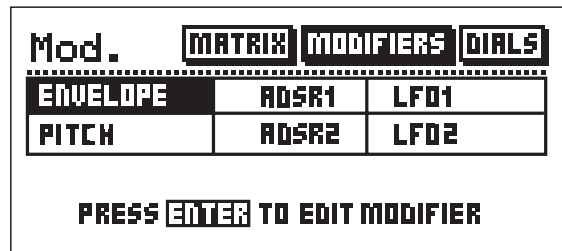

Pressing Enter will enable you to enter into the current selected Modifier. Here is an explanation of the parameters in the Modifiers.

Envelope Follower

The Envelope follower is used on effects that you would like to respond to the input signal like touch-wah or dynamic delay. The Envelope follower will perform the same dynamic movement as the input, but you can change the response time by using the Attack and Release.

- Attack - Sets the amount of time before the ENV reacts to the input signal.
- Release - The time that the ENV continues to work after the input signal stopped.

Pitch

To get optimal precision from the Pitch detection in the G-Force you must set best matching range according to the instrument you are playing.

Select between:

- 6s GTR D-E Default setting for a 6 string guitar. Accepts also the common dropped D tuning.
- 7s GTR A-E Use this tuning for a 7 string guitar. The G-Force responds to notes as low as A. However, the precision in such a low range may vary depending on your type of guitar setup.
- 4s Bass D-E Matches the range of a 4 string bass.

MODIFIER

ADSR 1&2

ADSR's are used to play short sequences triggered by the audio input. You set up a number of terms to describe the current sequence, and a trigger level also known as Threshold.

Attack

The Attack or rise time of the curve i.e. how long it takes to go from minimum to maximum level.

Decay

Sets how long it takes the curve to fall back from maximum to Sustain level.

Sustain

The amount of time that the ADSR will hold the Sustain level.

Sustain level

The value that will be sent out during the Sustain period.

Release

The amount of time that it takes the ADSR to fall from Sustain level to zero. Release time will take over when the Sustain time has expired (depending on the trig mode setting).

Mode

With the mode parameter parameter you can choose the way the ADSR should respond to trigs. In general the ADSR can only retrigger if the signal falls below threshold and comes back up.

- Once - Will run the ADSR to the end once, and afterthat be ready for a new trig. In "Once" mode the signal have to drop below threshold after the ADSR finished to be able to retrigger.
- Once-Retrig - Will run the ADSR to end once, but are capable of retriggering during the ADSR sequence.
- Loop - Will keep running the ADSR sequence for as long as the signal stays above threshold.
- Loop-Retrig - Will keep running the ADSR sequence for as long as the signal stays above threshold, but are capable of retriggering

during the ADSR sequence.

- Sustain - Will stay at Sustain level for as long as the signal stays above threshold.
- Sust-Retrig - Will stay at Sustain level for as long as the signal stays above threshold, but is capable of retriggering during the ADSR sequence.

Threshold

When the input level exceeds this level, the ADSR is triggered.

LFO 1&2

The LFO's can be used for various purposes, for example you can connect a balance parameter and create an extra panner or modulate a filter to create an auto-wah effect.

Both LFO1 & 2 have two outputs, which means that you can use the same LFO with different phase for different purposes.

- Speed - The speed of the LFO also known as Rate.
- Depth - The depth of the LFO also known as Width.
- Tempo - Sets the LFO speeds relationship to the tapped tempo (on the Tempo key). The subdivisions available are: Ignored 1/1, 1/2-1/32, straight, dotted or triplets.(1/4 equals BPM (beats per minute).
- Curve - Select the curve that you would like on the current LFO. Choose between: Square, Sine, and Triangle.

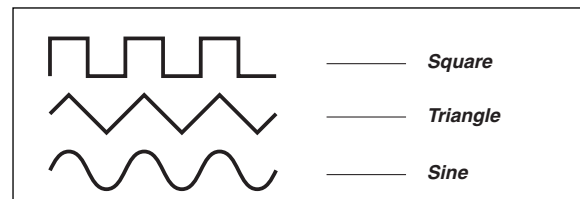

Pulsewidth

Controls the division of the upper and lower parts of the current curve, i.e. if Pulsewidth is set to 75%, the upper half of the curve will be on for 75% of the time.

MODIFIER



Out2 phase -An LFO phase change causes a small delay in the second waveform starting point. This means that out 1 and 2 start the current waveform at two different points.

Example: If Out2 phase is set to 180 degrees, Out 1 and 2 will be exactly opposite.

Dials

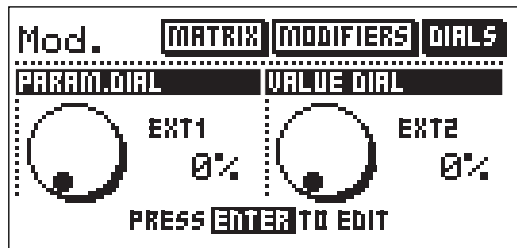

Press the Mod key and use the < > Arrow keys to select the Dials. (see picture on page 25). The basic idea with the dials are that you can simulate any of the eight External controllers using the Parameter and Value wheel. By dialing, you can test if the links in the Matrix are responding correctly without having a pedal connected.



If you want to make sure that you expression pedal is calibrated correctly, you can test it by watching the dials while moving your pedal from 0-100%.

Press Enter to change the External controllers simulated by the wheels. Use the Parameter wheel to select between Dial 1 or 2, and press Exit when you have set the desired external controllers to be simulated.

UTILITY

In the Utility display, you can choose between Config. and Billboard. Use the < > Arrow keys to select between the two displays.

Config.

User Interaction

In the config. display you can set up a number of global parameters for the G-Force such as memory protect, backup of the User bank, etc.

Display Viewing Angle

Adjust for best contrast of the LCD display.

Parameter dial direction

FWD - UP/DOWN: Select what direction the parameter wheel should move the display cursor.

Preset Change

Effect mute On

When set to on, the G-Force will mute the sound for a very short moment while changing the preset. With this feature you can avoid any kind of artifacts when changing presets.

Effect mute Off

When effect mute is set to off the G-Force will bypass the effect blocks according to the Mute mode set in each block, while changing preset.

Example: Preset 1 contains a Delay. The Mute mode of the Delay is set to "FX Input". Since "FX Input" will keep the dry signal at the level set by the Mix parameter of the block, this preset will do the same. (The; Mute mode is explained in the "Blocks " chapter).

To avoid level jumps at preset change, you must carefully consider the Mute mode of each block. "Mix 0%" will take the direct signal level up to 100% at the moment of the preset change. "FX In/Out" will keep the direct signal level

Utility

User Interaction

Display viewing angle
Parameter Dial Direction

Preset Change

Effect Muting
Extern Modifier Input

Environment

Pedal Type
Pedal Calibration
Pedal Curve
Tuner MIDI Out

User bank protect

Protect
Protect Lo-limit
Protect Hi-limit

User bank backup

User bank to Card
Card to User bank
User bank to MIDI
MIDI to User Bank

set by the Mix parameter in each block and “Input/Output” will mute the direct signal at preset change.

Extern Modifier Input

This function sets how externally controlled parameters should react at preset change.

Reset - Will preset the controlled parameter to the value stored in the preset. At the first movement of the External controller, the parameter will be captured.

Preserve - Will preserve the value of the external controller, meaning that the controlled parameter will start this value.

Example: You are about to load a preset with an external expression pedal controlling the Delay mix parameter. The Delay mix parameter is stored at 50%. Now you load this preset. If you selected “Reset” in the Ext. modifier input, the Delay mix will be reset to the preset value=50% If you selected “Preserve” in the Ext. modifier input, the Delay mix will preserve the pedal value=100%.

Environment

Pedal Type

Switches between momentary and alternating. This parameter should be set to alternating if you are using an expression pedal.

Pedal Calibration

Press Enter to enable calibration of the External input jack on the back panel of the G-Force. Follow the instructions in the display.

Pedal Curve

The response curve of the External 1/4” jack Input can now be adjusted. After the External Input is calibrated, select “Pedal Curve” in the “Utility - Config display”, and press ENTER. Use the VALUE wheel to change the response curve. Press EXIT to leave the “Pedal Curve” display. The “Pedal Curve” parameter is global, and is therefore not changed with presets.

Tuner MIDI Out

In the Utility menu, a Tuner MIDI Out parameter is added. This parameter should be set to “On” to utilize the Tuner-display function in a connected G•Minor pedal.



The Tuner MIDI Out parameter **MUST** be set to Off when performing a MIDI Bulk dump.



If MIDI Out is connected to another device than a G-Minor it may be advisable to use the “off” position to avoid sending inappropriate MIDI information to that device.

User Bank Protect

Protect

Sets the Protect function On/Off.

Protect Low limit

Sets the lower limit of the preset protect. The current number is included in the protect.

Protect High limit

Sets the higher limit of the preset protect. The current number is included in the protect.

User Bank Backup

You can backup the User presets of the G-Force to a card or MIDI recording device using these functions. Card type: SRAM PCMCIA, type 1, min. 64 K byte. Depending on the size of the PCMCIA card several banks on a single card is available.

User Bank to Card

Insert a PC-card in the Card slot and press Enter twice. All User presets of the G-Force will then be saved to the memory card.

Card to User bank

Insert a PC-card containing your presets and press Enter twice. All presets will now be stored back into the User bank of the G-Force.

WARNING: *This action will overwrite ALL User presets.*

User bank to MIDI

Connect your G-Force’s MIDI out to another G-Force, a sequencer or any other MIDI recordable device. Press Enter twice and the G-Force will perform a MIDI bulk dump of all User presets.

MIDI to User bank

Connect the storing device to the G-Force's MIDI In and press Enter. The G-Force is now ready to receive a MIDI bulk dump containing User presets.

WARNING: This action will overwrite ALL User presets.

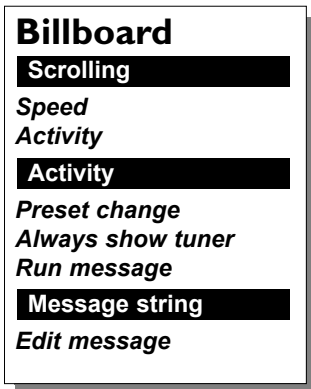

Run Message

The G-Force contains a global message that can always be shown or used like a screensaver. This parameter determines how often Global message is active.

Message String

Edit message

Press Enter when selecting this parameter to change the text of the global message. Select DONE and press Enter to finalize.

Billboard

In the Billboard display you can setup a number of terms for the Billboard.

Scrolling

Speed

Sets the scrolling speed of the Billboard.

Activity

Preset change

Sets the action that the Billboard will perform at preset changes. You can choose between sliding and running the name and the number of the current preset.

Always show Tuner

If this parameter is active, the Billboard will always show the Tuner note and indicators.



This parameter can also be set from the Tuner display.

TEMPO

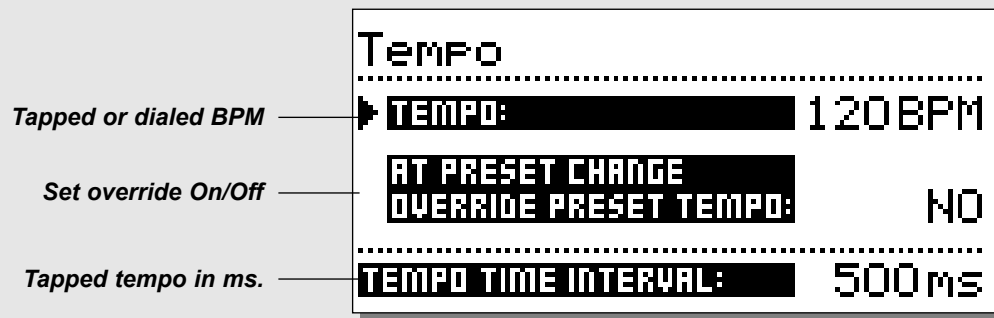

Tempo

Set the global tempo by tapping the Tempo key. The global tempo can be used as a common tempo guide in all presets. All Delay algorithms and all algorithms containing a speed are able to use the global tempo.

Tapping a tempo into a Delay

All Delay and Speed parameters have links to the Global Tempo menu. This means that a tapped tempo can be used in any presets that have these parameters. To make the tempo fit your purpose, we added a subdivision in all these algorithms. All you have to do is set up which subdivision parameter you would like the tempo to divide into.

Example: You want a Delay to perform 1/8 triplets. Go into the Edit parameter page of the Delay and select 1/8 T. Now you can just tap the BPM on the Tempo key (or via a pedal), and the Delay will automatically recalculate into 1/8 triplets in the current tempo. The same goes for all the algorithms containing Speeds.

The algorithms able to use the global tempo are:

- Delay
- Chorus
- Flanger
- Phaser
- Tremolo
- Panner
- and modifiers
- LFO 1
- LFO 2

The Tempo display

Tapping the Tempo key will cause the Tempo display to pop up, and the Billboard will be blinking at the current tempo. Both the Tempo display and the blinking Billboard will disappear automatically after a few seconds.

In the Tempo display, you can see the BPM (Beats per minute) tapped in, or you can dial a BPM placing the cursor on Tempo, and dialing the Value Wheel.

Maximum tempo - 300 BPM.

Minimum tempo - 20 BPM.

Override preset tempo at preset change

Controls whether the tempo should be influenced instantaneously at preset changes or if the new preset should await the next tapped tempo.

Example: You are using a preset with a straight 1/4 note delay, and you tapped the tempo into the G-Force, let's say 120 BPM, meaning that you have tapped a Global Tempo of 500 ms. Now you change preset, and the new preset is suppose to use 1/8 triplets. Do you want the preset to use the existing tempo right away, or do you want the preset to wait for the next tapped tempo.?

Selecting Yes, will enable the presets to use the tempo instantaneously at preset changes.

Tempo controlled via pedal/MIDI

The Tempo can be tapped via the External input jack on the back panel of the G-Force or via a MIDI On/Off switch. That is setup in the I/O Setup, control display.

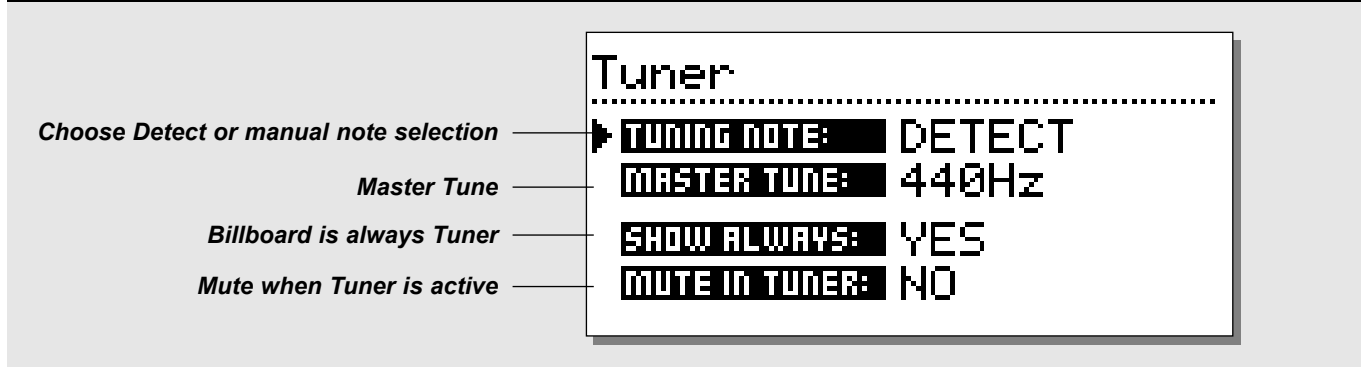

The Tuner display

When pressing the Tuner key, you access the Tuner display. In the Tuner display, you have four setup parameters. Entering the Tuner display also activates the Tuner guides on both the Billboard and the Gain reduction meters.

Tuning Note

With this parameter you can either choose the Detect mode or you can manually select which note you want to tune. When the tuner is set to Detect it will automatically sense what note you are playing. This will be indicated on the Billboard together with two arrows showing you whether you are a bit flat or sharp. At the same time the gain reduction meters will indicate how much you are out of tune. When the two center LEDs are lit, you are in tune.

Master tune

With the Master tune parameter you can calibrate the tuner.

Note: The Master Tune controls the pitch detector, meaning that the tuning of the Pitch voices will change with the Master tune.

Show always

When "Show Always" is on, the Billboard will show the Tuner constantly. This allows you to always be able to turn around and see if you are in tune. This parameter is also available in Utility.

Mute in Tuner

This parameter enables you to mute the outputs of the G-Force when the Tuner is activated. This means that you

can tune your guitar on stage with no sound at all. The sound will only be muted while the tuner display is active.

Tuner activated via pedal/MIDI

The Tuner can be activated via the External input jack on the back panel of the G-Force or via MIDI. That is setup in the I/O Setup, Control display.

Algorithms

This chapter will go through all Edit parameters in the eight blocks and the Input and Output sections.

Mute mode

The eight effect blocks all have a number of different Mute modes. They are located as the last parameter in the Edit list of each block.

The idea is that you can decide how every single block should react when you push the current blocks bypass key on the front panel. Here is the description of what the five modes will do when bypassed:

Mix 0%: Will mute the output of effect, and take direct signal level up to 100% dry = 0% effect.

FX Out: Will mute the output of the effect, and preserve direct signal level, according to Mix.

Output : Will mute both the output of the effect and the direct signal.

FX In : Will mute the input of the effect, and preserve the direct signal level. This enables the block to finish an effect tail after being bypassed, e.g. using this mute mode on a delay will let the delay tail ring out even after being bypassed or at preset change between two presets with the same settings (only the Delay, Reverb and Pitch has this mute mode).

Input: Will mute both the input of the effect and the direct signal. Same basic function as FX In, only this mode will also mute the direct signal. (only the Delay, Reverb and Pitch have this mute mode).



Using the Input/Output mute modes will mean that no signal passes through the current block when bypassed.

Gate

The basic idea about a Gate is that when the input signal falls below a threshold set up by you, the Gate turns down the signal by a certain number of dB's, also set by you.

Example: You set the Threshold at -25dB and the Max. damping at 30dB. When playing signal into the G-Force, the Gate will not do anything, but when the input signal is lower than -25dB (on the input meter) the Gate will start damping to a maximum of 30dB (see the Noise Gate meter). The speed of the damping is set by the Release rate parameter (Rel.rate).

In the In-section of the G-Force, you find the Noise Gate. The gain reduction of the Noise Gate is displayed by the LEDs below the Billboard.

The Noise Gate (including the Level parameter) is not bypassed by the overall Bypass key. This means that the Noise Gate will still be active even if you bypass all the effects of the G-Force.

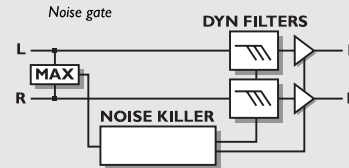

NOISE GATE

Mode

Using the mode selector, you can choose between Hard and Soft Gating. Hard damps almost instantaneously when the Input falls below the Threshold, while Soft damps gradually, meaning damping very smooth and soft, without destroying your sustain.

Threshold

When the input level falls below this Threshold, the Noise Gate is activated.

Max. Damping

The maximum of dB's that the Noise Gate can damp (also called gain reduction), meaning if Max. Damping is set to 0 dB, the Noise gate will not damp at all. The damping/Gain reduction is displayed on the meters below the Billboard.

Release rate

The Release rate sets the speed that the Noise Gate damps with, meaning if the parameter is set to 100dB pr. second, the Noise Gate will damp very quickly.

Level

This level control can be used for controlling the In Level of the different presets. By setting the Level at -6dB, in all your basic presets, you reserve a little extra level for your lead presets. The Level parameter is also found in the Modifier Matrix, and can therefore be controlled via pedal or MIDI.

Compressor

A Compressor is meant to reduce the dynamic content of the input signal, and thereby keep a more constant level. When the input signal exceeds the threshold, the Compressor starts to reduce the signal according to the Ratio. The Ratio describes how much the signal is reduced, e.g. a Ratio at 2:1 means that for every 2 dB the signal exceeds the threshold, only 1 dB comes out. When the signal falls below the Threshold, the Compressor is supposed to stop working, but the Release parameter can slow that process down. The Release parameter determines how long the Compressor should continue to work after the signal dropped below Threshold.

Example: The Compressor is set to a Ratio of 8:1, and the signal is exceeding the Threshold by 16dB, that will result in a gain reduction of 14dB (viewed on the Compressor gain reduction meter). The Release time is set to 28 dB/S. This means that when the signal falls below the Threshold it will take the Compressor 0.5 second to fall back to no gain reduction.

The Compressor in the G-Force comes in both a simple and an advanced version. The Compressor uses auto-makeup-gain. This means that the Compressor automatically compensates for the loss of level caused by the gain reduction, by turning the outlevel up i.e. the more you compress, the higher level you get out.

The Attack time is scaled automatically depending on the dynamic content of the incoming signal.

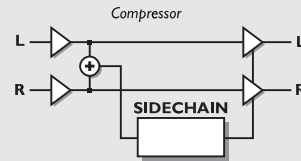

COMPRESSOR

Threshold

When the input level exceeds the Threshold, the Compressor will be activated. This means that the lower the Threshold, the more compression you will get.

Ratio

Ratio effects the steepness of the Compressor. Example: When the Ratio is set to 2:1 it means that for every 2db the input level rises, the output level increases by 1 dB.

Knee Mode (only in advanced)

The Knee Mode parameter sets the bending point of the compressor to soft knee or hard knee. When soft knee is selected, the Compressor will gradually reach the ratio, while hard knee will cause the Compressor to go directly from no compression to the current ratio.

Release (only in advanced)

Release sets the fall back time of the Compressor, after the signal dropped below Threshold, meaning if the Compressor is reducing the gain by 14dB and the Release is set to 28dB/S, it will take 0.5 second before the Compressor stops gain reduction.

In Level

Controls the input level of the block.

Out Level

Controls the output level of the Compressor block.

Filters

The Filter block contains five different sub-algorithms: Parametric EQ, Wah Wah, Formant, Resonance and Phaser. These five algorithms perform several effects in a range from subtle to wacky.

Parametric Equalizer

The parametric EQ contains two shelving filters (#1 and #5) and three bell filters (#2, #3, #4).

A low shelving filter is a filter that works from a certain target frequency and down, meaning everything below the target frequency will be adjusted. A high shelving filter is equal to low shelving but now all the frequencies above the target are adjusted.

A bell filter is a filter that works around a target. This means that a certain number of the adjacent frequencies are adjusted. The affected number of adjacent frequencies is adjusted by the BW (bandwidth) parameter.

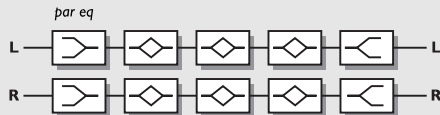

PARAMETRIC EQ

Freq

Use the freq parameter to set the target frequency of the current band.

Slope/BW (bandwidth)

Use the Slope parameter to adjust the steepness of the shelving filter. Bandwidth adjusts how broad the bell filters are.

Gain

Use the gain to boost or cut the target frequency. All filters can boost or cut +/-12dB.

In Level

Controls the input level of the block.

Out Level

Controls the output level of the block.

Mute mode

See Mute mode in the introduction of this chapter.

Resonance

The Resonance filters are basically a high and low cut filter that can be swept up and down the frequency range. When the Resonance (Q-factor) parameter is increased, the filter's peak at the cutoff frequency gets very narrow and very steep. That is at the very core of the characteristic sound of Resonance filters.

NOTE: The peak of the filters can get very loud and can easily hit the internal ceiling and thereby cause distortion. To prevent that, turn down the input level of the Filter block.

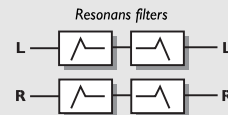

RESONANCE

Order

The Order parameter of the resonance filters changes the steepness of the filters. 2nd order filters are 12dB/Octave while 4th order are 24dB/Octave. 4th order filters will "ring" or resonate more than 2nd order filters.

Locut freq

Sets the frequency of the Locut resonance filter.

Hicut Freq

Sets the frequency of the Hicut resonance filter.

Lo Resonance

Sets the amount of resonance on the Locut filter.

Hi Resonance

Sets the amount of resonance on the Hicut filter.



Try to connect an LFO or an expression pedal to the two frequency parameters using the Modifier Matrix.

Mix

Mix between direct sound and effect.

In Level

Controls the input level of the block.

THE BLOCKS

Out Level

Controls the output level of the block.

Mute mode

See Mute mode in the introduction of this chapter.

Wah Wah

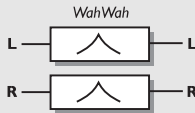

WAH WAH

Freq

The frequency of the Wah Wah. Connect this parameter to an LFO, ENV or an expression pedal and you will get Autowah, Touchwah, or Manual Wah.

Instrument mode

This parameter changes the range of the Wah Wah between guitar and bass ranges.

Mix

Mix between direct sound and effect.

In Level

Controls the input level of the block.

Out Level

Controls the output level of the block.

Mute mode

See Mute mode in the introduction of this chapter.

Formant filters

The Formant filters are somewhat special. They can create a new sound for you. Imagine a pedal that does not say WAH WAH, but instead goes OOWEE-OOWEE. Formants are also known as the vowels of human speech. The basic idea is that you set three coordinates, Start, Thru and End in a frequency area, and then move your sound up and down the curve you created with the coordinates.



FORMANT CURVE

Start

The Starting point of the formant curve.

Thru

The Thru point of the curve

End

The End point of the curve

Resonance

Sets the amount of resonance on the Formant filter.

Age/Sex

Is used to change the character of the formant curve. Try to experiment a bit with this parameter.

Sweep

Dial the Sweep parameter to move up and down the formant curve. This is the parameter that you should connect to a pedal or some other modifier.



Try to connect the Sweep parameter to an LFO, ENV or an expression pedal for realtime parameter control.

Mix

Mix between direct sound and effect.

In Level

Controls the input level of block.

Out Level

Controls the output level of the block.

Mute mode

See Mute mode in the introduction of this chapter.

Phaser

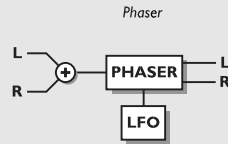

PHASER

Speed

Controls the speed of the Phaser.

Tempo

The Tempo parameter sets the relationship to the global Tempo e.g. if you set it to 1/4T you will get quarter note triplets of the tapped tempo. 1/4 equals the BPM (tapped Tempo).

If you select "Ignored" the current parameter will use the Preset value and will not be affected by the Global Tempo.

Depth

Adjusts the Depth of the Phaser.

Order

Sets the number of filters used to produce the Phaser. The three possibilities 4, 8 and 12 are very different sounding. Check them out.

Feedback Level

Controls the amount of feedback in the Phaser. Note that this parameter can be negative, meaning feedback in reversed phase.

Instrument Mode

With the mode parameter you can choose between the guitar or bass range of the Phaser.

Mix

Mix between direct sound and effect.

In Level

Controls the input level of the block.

Out Level

Controls the output level of the block.

Mute mode

See Mute mode in the introduction of this chapter.

Pan+Trem block

A Panner is basically a change of the level opposite in left and right channels. An LFO is connected to these levels and turns them up and down. A Tremolo is also a change of level controlled by an LFO except the level change in left and right channels are identical. So the basic difference between a Panner and a Tremolo is whether the level change of left and right channels is opposite or identical.

This Panner has a surround range, meaning that it will pan further than a normal stereo image.

The Tremolo has flexibility that you will not see in any stomp box.

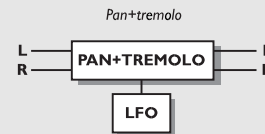

TREMOLO / PAN

Tremolo

Speed

Controls the how fast the Tremolo is pulsing.

Tempo

The Tempo parameter sets the relationship to the global Tempo e.g. if you set it to 1/4T you will get quarter note triplets of the tapped tempo. 1/4 equals the BPM (tapped Tempo).

If you select "Ignored" the current parameter will use the Preset value and will not be affected by the Global Tempo.

Depth

Will set the intensity of the Tremolo, or how deep it sweeps.

THE BLOCKS

Curve (only in Advanced)

Sets the curve of the LFO. Choose between: Square, Sine, or Triangle.

The most common LFO curve in Tremolo is Triangle.

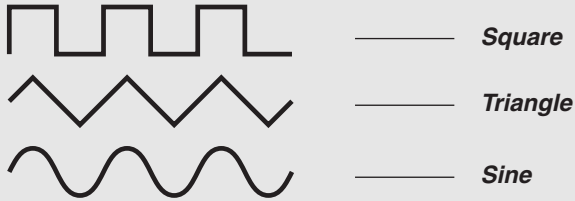

Try the Square waveform with 100% Depth, to get holes in your guitar sound (called Transforming).

Pulsewidth (only in Advanced)

Controls the division of the upper and lower part of the current waveform, e.g. if Pulsewidth is set to 75%, the upper half of the waveform will be on for 75% of the time.



LFO Phase (only in Advanced)

An LFO phase change causes a small delay in one of the waveform starting points. This means that left and right outputs start the current waveform at two different points.

Example: If LFO phase is set 180°, left and right will be exactly opposite.

Mix

Mix between direct sound and effect.

In Level

Controls the input level of the block.

Out Level

Controls the output level of the block.

Mute mode

See Mute mode in the introduction of this chapter.

Panner

Speed

Controls the speed of the Panner. The simple Panner always pans fully left and right.

Tempo

The Tempo parameter sets the relationship to the global Tempo e.g. if you set it to 1/4T you will get quarter note triplets of the tapped tempo. 1/4 equals the BPM (tapped Tempo).

If you select "Ignored" the current parameter will use the Preset value and will not be affected by the Global Tempo.

Curve (only in Advanced)

Sets the curve of the LFO. Choose between: Square, Sine, or Triangle.

The most commonly used curve in Panning is Sine.

Pulsewidth (only in Surround Panner)

Controls the division of the left and right part of the current waveform, i.e. if Pulsewidth is set to 75%, left channel will be on for 75% of the time. (see pulsewidth figure in Tremolo).

LFO Phase (only in Surround Panner)

An LFO phase change causes a small delay in one of the waveform starting points. This means that left and right outputs start the current waveform at two different points.

Example: If LFO phase is set 180°, left and right will be exactly opposite.

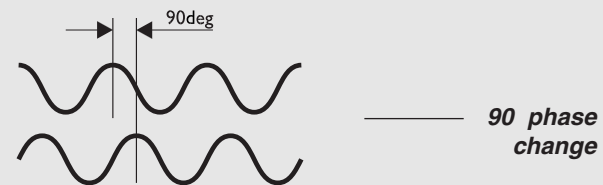

LFO PHASE

Pan Center

Using this parameter, you can move the center of the Panner.



Large increments of the Pan Center, in combination with a broad Depth will cause the Panner to pan beyond a normal stereo image.

Width (only in Surround Panner)

Controls the Width of the Panner. When Width is set to more than 100%, the Panner will pan beyond a normal stereo image. Check it out.

Mix

Mix between direct sound and effect.

In Level

Controls the input level of the block.

Out Level

Controls the output level of the block.

Mute mode

See Mute mode in the introduction of this chapter.

The Pitch block

In the Pitch block there are two basic Pitch types: Fixed and Intelligent. The difference between the two types is that while the Intelligent pitcher is capable of staying inside a certain key and scale, the Fixed pitch will always add the exact same amount of pitch no matter the input signal.

The Detune algorithm is used for smaller amounts of pitch, to create doubling sounds.

The optimal pitch detection is achieved by placing the Pitch block as close to the Input section as possible. It is very important to be in tune when playing with the Intelligent pitcher. Use the Tuner for that purpose.

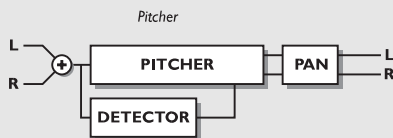

INTELLIGENT PITCHER

Key

With this parameter you are able to tell the G-Force which key you are playing in. This is very important information, because the voices of the intelligent pitcher are generated from it.

Scale

Sets the scale that the Intelligent Pitcher uses, meaning that the voices from the G-Force will be within this current scale. It is recommended that this scale be equal to the scale you are playing, otherwise you might get some very strange voicings.

Mode

Choose the mode of the Intelligent Pitcher.

Stepped: The Pitcher will only play notes within the current scale and key no matter what you play.

Smooth: The Pitcher will follow the incoming signal.

This means that you can bend a tone, and the Pitcher will bend with you.

Voice 1-2

Sets the step in the current scale and key in which you want the pitcher to play.

Example: You want the G-Force to play the third step in C-Major. Set the Key to C, and the Scale to Ionian Major. Now set Voice 1 to step 3. No matter what you play within C-Major the G-Force will now play/transpose two steps further up the scale, i.e. if you play a C now, the G-Force will play an E which is the third step of C-Major.

Max. pitch is +/- one octave.

Detune Voice 1-2

Adjusts the detune of the two Voices. By connecting an LFO to these parameters you can add a vibrato to the pitch voices.

Delay 1-2

Sets the Delay of the each of the two voices. Max. delay time per voice is 400 ms.

Pan Position 1-2

Controls the panning of each of the two pitch voices.

Level 1-2

Sets the level of the two pitch voices.

Mix

Mix between direct sound and effect.

In Level

Controls the input level of the block.

Out Level

Controls the output level of the Intelligent Pitcher block.

Mute mode

See Mute mode in the introduction of this chapter.

Custom Scale

The Custom scale enables you to make your own scale, by specifying the number of notes, the root key and the specific notes contained in the current scale.

Notes used

Use this parameter to specify the number of notes within your Custom scale. A Custom scale must contain a minimum of 4 and maximum of 8 notes.

Tonic

Sets the root key of your Custom Scale.

Note 2 - 8

Use these parameters to specify the notes you want in your Custom scale. You can only specify the number notes set by the "Notes Used" parameter. The Custom scale must be described within an octave.

Fixed 1 & 2 Voice Pitch

Voice 1-2

Sets the amount of pitch on each of the two voices. Maximum pitch is +/- 12 semitones.

Delay 1-2

Sets the Delay of the each of the two voices. Maximum delay time per voice is 400 ms.

Level 1-2

Sets the level of the two pitch voices.

Pan Position 1-2

Controls the panning of each of the two pitch voices.

Feedback 1-2

Sets the amount of Feedback on the two voices. This can create really weird effects since the signal will be pitched over and over meaning that it will rise/fall more and more over a period of time.

Mix

Mix between direct sound and effect.

In Level

Controls the input level of the block.

Out Level

Controls the output level of the Pitch block.

Mute mode

See Mute mode in the introduction of this chapter

2 Voice 2 Octave

Voice 1 & Voice 2

Sets the amount of pitch on each of the two voices. Maximum pitch is +/- 24 semitones.

Delay - Voice1 & Voice 2

Sets the Delay of the each of the two voices. Maximum delay time per voice is 400 ms.

Pan Position 1-2

Controls the panning of each of the two pitch voices.

Feedback 1-2

Sets the amount of Feedback on the two voices. This can create really weird effects since the signal will be pitched over and over meaning that it will rise/fall more and more over a period of time.

Mix

Mix between direct sound and effect.

In Level

Controls the input level of the block.

Out Level

Controls the output level of the Pitch block.

Mute mode

See Mute mode in the introduction of this chapter

Detune

Voice 1-2

Sets the amount of pitch on each of the two voices. Maximum pitch is +/- 50 cents.

Delay 1-2

Sets the Delay of the each of the two voices. Maximum delay time per voice is 400 ms.

Pan Position 1-2

Controls the panning of each of the two detune voices.

Level 1-2

Sets the level of the two detune voices.

Mix

Mix between direct sound and effect.

In Level

Controls the input level of the block.

Out Level

Controls the output level of the Pitch block.

Mute mode

See Mute mode in the introduction of this chapter.

Delay

The Delay block has five different sub-algorithms: Stereo, Dual, Dual Two-tap, One-tap and Quad-tap. Effect Spillover from one preset to another can be obtained by using the same sub-algorithm, and combination of Mute mode = "Fx In" and bypassing the current block.

Example: If you want to leave a Delay tail hanging over a preset change, make sure to keep the same sub-algorithm in both presets. In addition to that you should select the "Fx In" Mute mode and just bypass the Delay block in the second preset.

Changing parameters like the Feedback or Mix over a preset change can kill the Delay.

Stereo Delay

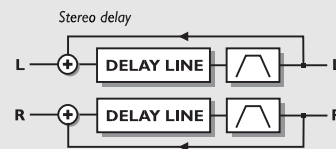

STEREO DELAY

Time

Sets the delay time of both Left and Right channel. Maximum delay time is 740 ms.

Tempo

The Tempo parameter sets the relationship to the global Tempo e.g. if you set it to 1/4T you will get quarter note triplets of the tapped tempo. 1/4 equals the BPM (tapped Tempo).

If you select "Ignored" the current parameter will use the Preset value and will not be affected by the Global Tempo.

Feedback

Adjusts the Feedback of both Left and Right channels.



If the Feedback parameter is set to 100%, the G-Force will loop Delay signal. Connect an Expression pedal and check out preset 174 and 175 for a start.

THE BLOCKS

Lowcut

Cuts off frequencies lower than the selected frequency. The slope of the filter is 12dB/octave.

Highcut

Cuts off frequencies higher than the selected frequency. So if you feel that there is too much treble in your signal, you remove this by adjusting the highcut filter down. The slope of the filter is 12dB/octave.

Mix

Mix between direct sound and effect.



Connect this parameter (Mix) to the Envelope follower in the Modifier Matrix to create dynamic delay.

In Level

Controls the input level of the block.

Out Level

Controls the output level of the Delay block.

Mute mode

See Mute mode in the introduction of this chapter.

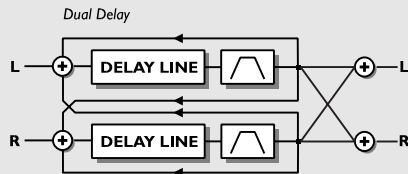

DUAL DELAY

Time 1

Sets the delay time of the first Delay tap. Maximum delay time is 740 ms.

Time 2

Sets the delay time of the second Delay tap. Maximum delay time is 740 ms.

Tempo 1&2

The Tempo parameter sets the relationship to the global Tempo e.g. if you set it to 1/4T you will get quarter note triplets of the tapped tempo. 1/4 equals the BPM (tapped Tempo).

If you select "Ignored" the current parameter will use the Preset value and will not be affected by the Global Tempo.

Feedback 1 to 1/Feedback 2 to 2

Sets the amount of feedback from Delay 1 to 1 and from Delay 2 to 2.



The sum of the four feedbacks is limited to 100%.

Feedback 1 to 2/ Feedback 2 to 1.

Sets the amount of cross feedback from Delay 1 to 2 and Delay 2 to 1.

Levels

Sets the level of each of the two delay lines.

Pan 1-2

Controls the panning of the two Delay taps.



Connect a LFO to one or both of these parameters and you have an extra autopanner.

Lowcut 1-2

Cuts off frequencies lower than the selected frequency. The slope of the filter is 12dB/octave.

Highcut 1-2

Cuts off frequencies higher than the selected frequency. So if you feel that there is too much treble in your signal, you remove this by moving the highcut down. The slope of the filter is 12dB/octave.

Mix

Mix between direct sound and effect.

In Level

Controls the input level of the block.

Out Level

Controls the output level of the Delay block.

THE BLOCKS

Mute mode

See Mute mode in the introduction of this chapter.

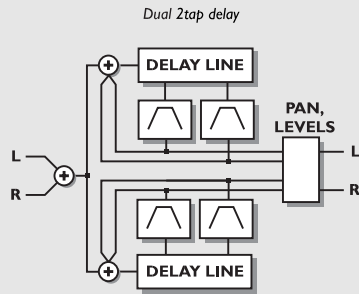

DUAL TWO TAP DELAY

Dual Two Tap Delay

The Dual Two Tap Delay is capable of performing two delay taps on each of the two delay lines. The two delay lines have their own Input level, which basically means that they perform much like two individual delay processors.

Delay line 1&2

Time 1-2

Sets the delay time of the two taps on Delay line 1. Maximum delay time per tap is 1480 ms.

Tempo

The Tempo parameter sets the relationship to the global Tempo e.g. if you set it to 1/4T you will get quarter note triplets of the tapped tempo. 1/4 equals the BPM (tapped Tempo).

If you select "Ignored" the current parameter will use the Preset value and will not be affected by the Global Tempo.

Feedback 1-2

Sets the amount of feedback on Tap 1 and 2.

NOTE: The sum of the two feedbacks is limited to 100%.

Levels 1-2

Sets the level of each of the two taps.

Pan position 1-2

Controls the panning of the two Delay taps.

Lowcut 1-2

Cuts off frequencies lower than the selected frequency. The slope of the filter is 12dB/octave.

Highcut 1-2

Cuts off frequencies higher than the selected frequency. So if you feel that there is too much treble in your signal, you remove this by adjusting the highcut filter down. The slope of the filter is 12dB/octave.

Line Level 1-2

Adjusts the input level of the two Delay lines. This enables you to lower the level of one of the two lines without affecting the second. The Line level is a percentage adjustment of the algorithm In Level.



These levels can be used for creating spillover from a slap back Delay in Line 1 to a slower lead Delay in Line 2. Turn the level of Line 1 up and the Level of Line 2 down in Preset 1 and the other way around in preset 2. The Delays will now ring out across the preset change.

Mix

Mix between direct sound and effect.

In Level

Controls the input level of the block.

Out Level

Controls the output level of the Delay block.

Mute mode

See Mute mode in the introduction of this chapter.

One Tap Delay

Time

Sets the delay time. Maximum delay time is 1480 ms.

Tempo

The Tempo parameter sets the relationship to the global Tempo e.g. if you set it to 1/4T you will get quarter note triplets of the tapped tempo. 1/4 equals the BPM (tapped Tempo).

If you select "Ignored" the current parameter will use the Preset value and will not be affected by the Global Tempo.

Feedback

Adjusts the amount of Feedback.

Pan position

Controls the panning of the Delay.

Lowcut

Cuts off frequencies lower than the selected. The slope of the filter is 12dB/octave.

Highcut

Cuts off frequencies higher than the selected frequency. So if you feel that there is too much treble in your signal, you remove this by adjusting the highcut filter down. The slope of the filter is 12dB/octave.

Mix

Mix between direct sound and effect.

In Level

Controls the input level of the block.

Out Level

Controls the output level of the Delay block

Mute mode

See Mute mode in the introduction of this chapter.

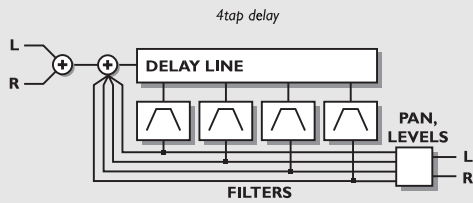

QUAD TAP DELAY

Quad Tap Delay

Tap 1-4

Sets the delay time of the four taps. Maximum delay time per tap is 1480 ms.

Tempo 1-4

The Tempo parameter sets the relationship to the global Tempo e.g. if you set it to 1/4T you will get quarter note triplets of the tapped tempo. 1/4 equals the BPM (tapped Tempo).

If you select "Ignored" the current parameter will use the Preset value and will not be affected by the Global Tempo.

Feedback 1-4

Adjusts the amount of Feedback from each of the four taps.

NOTE: The sum of the four feedbacks are limited to 100%.

Levels 1-4

Sets the level of each of the four taps.

Pan position 1-4

Controls the panning of the four Delay taps.

Lowcut 1-4

Cuts off frequencies lower than the selected. The slope of the filter is 12dB/octave.

Highcut 1-4

Cuts off frequencies higher than the selected frequency. So if you feel that there is too much treble in your signal, you remove this by adjusting the highcut filter down. The slope of the filter is 12dB/octave.

Mix

Mix between direct sound and effect.

In Level

Controls the input level of the block.

Out Level

Controls the output level of the Delay block

Mute mode

See Mute mode in the introduction of this chapter.

The Drive

The Drive block

The Drive is a post distortion. It can be used for effects purposes like overdriving a Delay, a Flanger or a Phaser etc. or simply to crank the overall sound a bit.

Drive

The Drive parameter is simulating the In-gain of a distortion device. The extra In-gain is automatically compensated on the Output level, to avoid any clipping internally.

Brightness

Brightness is used to reduce the amount of high frequency content in the distorted signal. The Brightness control is flat when set to 100%.

Body

Body is used to reduce the amount of low frequency content in the distorted signal. At heavy distortion the Drive will emphasize a lot of low frequencies, which can be somewhat annoying. These problems can be reduced by the Body parameter. A number of preamps and pedals on the market combine a lowcut filter with their In-gain to compensate for the exact same problem.

Smasher

The Smasher is used to change the character of the distortion by emphasizing even order harmonics. Setting this parameter to a high value, will smash your signal. Try to experiment with the character of your distortion.

Out Drive

Outdrive is simulating the kind of distortion that you would get from the output stage of an amplifier.

Mix

Mix between direct sound and effect.

In Level

Controls the input level of the block.

Out Level

Controls the output level of the Drive block.



Connect this parameter to the Envelope follower in the Modifier Matrix to eliminate noise from the Drive.

Mute mode

See Mute mode in the introduction of this chapter.

The Chorus/Flanger Block

The Chorus block is based on the heritage of the TC 2290 Dynamic Delay and 1210 Chorus/Flanger.

A Chorus/Flanger is basically a short delay that gets modulated by an LFO. The difference between Chorus and Flanging is the Feedback of the Flanger. That is the parameter that gives you that classic mid-range tone. The modulation of the short delay gives very small variations in pitch, these pitch changes blended with the direct sound gives you the Chorus sound, while the modulated signal alone will give you a Pitch modulator also known as Vibrato.

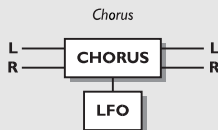

CHORUS/FLANGER

Classic Chorus

The Classic Chorus uses a relationship between Speed and Depth called the Golden Ratio. The G-Force inherited this feature from the TC 2290.

Speed

The speed of the Chorus, also known as Rate.

Tempo

The Tempo parameter sets the relationship to the global Tempo e.g. if you set it to 1/4T you will get quarter note triplets of the tapped tempo. 1/4 equals the BPM (tapped Tempo).

If you select "Ignored" the current parameter will use the Preset value and will not be affected by the Global Tempo.

Depth

Adjusts the depth of the Chorus, also known as Intensity.

Mix

Mix between direct sound and effect.

In Level

Controls the input level of the block.

Mute mode

See Mute mode in the introduction of this chapter.



Create a Vibrato by setting the Mix at 100%, Depth at 5-10% and Speed to 1-2 Hz.

Advanced Chorus

Advanced Chorus adds some extra parameters like LFO Phase and Curve.

Speed

The speed of the Chorus, also known as Rate.

Tempo

The Tempo parameter sets the relationship to the global Tempo e.g. if you set it to 1/4T you will get quarter note triplets of the tapped tempo. 1/4 equals the BPM (tapped Tempo).

If you select "Ignored" the current parameter will use the Preset value and will not be affected by the Global Tempo.

Depth

Adjusts the depth of the Chorus, also known as Intensity.

Delay

As described earlier, a Chorus/Flanger is basically a Delay being modulated by an LFO. This parameter makes it possible to change the length of that Delay. A typical Chorus uses delays at approximately 10 ms, while a Flanger uses delays at around 5 ms.

Golden Ratio

Sets the Golden Ratio between Speed and Depth On/Off. If you want to create wild Chorus sounds you may want to turn the Golden Ratio off.

Phase Reversed

Reverses the phase of the right channel, but only on the effect signal. This function makes the stereo image much wider.

LFO Curve

Sets the curve of the LFO. Choose between: Sine or Triangle. The most commonly used waveform in Chorus is Sine. (see curve figures in Tremolo)

LFO Phase

An LFO phase change causes a small delay in one of

the waveform starting points. This means that left and right outputs start the current waveform at two different points.

Example: If LFO phase is set 180°, left and right will be exactly opposite.

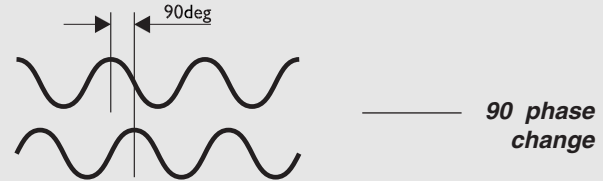

LFO PHASE

Mix

Mix between direct sound and effect.

Inlevel

Controls the input level of the block.

Mute mode

See Mute mode in the introduction of this chapter.

Flanger Classic

The Classic Flanger uses a relationship between Speed and Depth called the Golden Ratio. The G-Force inherited this from the TC 2290.

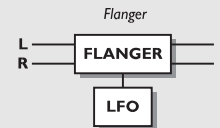

FLANGER CLASSIC

Speed

The speed of the Flanger, also known as Rate.

Tempo

The Tempo parameter sets the relationship to the global Tempo e.g. if you set it to 1/4T you will get quarter note triplets of the tapped tempo. 1/4 equals the BPM (tapped Tempo).

If you select "Ignored" the current parameter will use the Preset value and will not be affected by the Global Tempo.

Depth

Adjusts the depth of the Flanger, also known as Intensity.

Feedback

Controls the amount of feedback in the Flanger. Note that this parameter can be negative, i.e. feedback in reversed phase.

Mix

Mix between direct sound and effect.

In Level

Controls the input level of the block.

Mute mode

See Mute mode in the introduction of this chapter.

Advanced Flanger

Advanced Flanger adds some of extra possibilities like Cross Feedback, LFO phase and Curve.

Speed

The speed of the Flanger, also known as Rate.

Tempo

The Tempo parameter sets the relationship to the global Tempo e.g. if you set it to 1/4T you will get quarter note triplets of the tapped tempo. 1/4 equals the BPM (tapped Tempo).

If you select "Ignored" the current parameter will use the Preset value and will not be affected by the Global Tempo.

Depth

Adjust the depth of the Flanger, also known as Intensity.

Delay

As described earlier, a Chorus/Flanger is basically a Delay being modulated by an LFO. This parameter makes it possible to change the length of that Delay. A typical Chorus uses delays at approximately 10 ms, while a Flanger is uses delays at around 5 ms.

Feedback

Controls the amount of feedback in the Flanger. Note that this parameter can be negative, i.e. feedback in reversed phase.

Golden Ratio

Sets the Golden Ratio between Speed and Depth On/Off. If you want to create wild Flanger sounds, you may want to turn the Golden Ratio off.

Phase Reversed

Reverses the phase of the right channel, but only on the effect signal. This function makes the stereo image much wider.

Cross Feedback

Controls the amount of feedback between the two channels. Note that the Crossfeed can be negative, i.e. Crossfeed in reversed phase.

LFO Curve

Sets the curve of the LFO. Choose between: Sine or Triangle.

The most commonly used waveform in Flanging is Sine. (see curve figures in Tremolo)

LFO Phase

An LFO phase change causes a small delay in one of the waveform starting points. This means that left and right outputs start the current waveform at two different points.

Example: If LFO is set 180°, left and right will be exactly opposite.
(See the LFO phase figure in the Chorus section).

Mix

Mix between direct sound and effect.

In Level

Controls the input level of the block.

Mute mode

See Mute mode in the introduction of this chapter.

The Reverb Block

The Reverb in the G-Force is based on the heritage of the M5000 and M2000, and are tuned for guitar use.

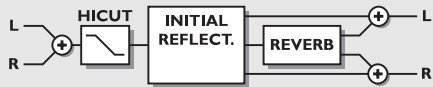

REVERB

The Reverb section of the G-Force can create a variety of Reverb effects including the feature of emulating the initial reflections of a room which creates some mind blowing spatial effects until now only available in the TC M5000.

When using the G-Force reverb, you should see the reverb as two parts:

1. Initial room reflections
2. The Decay

The initial room reflections are, depending on the size of the room, the first 50-200ms of the Reverb and it is these reflections that contains the information of the size and shape of a room and create the width and most of the depth experienced in a real hall or room.

The Decay is the later part of a natural reverb which is experienced as prolonging the sound and creating some depth behind the source or direct signal, but integrating it in the spatial characteristics of the hall or room, like you experience in natural ambience or reverb.

By emulating the initial room reflections the G-Force can create some very deep and wide stereo images placing the source or direct signal in the hall/room without using long decay times which often makes the sound image very "crowded" and disturbs your playing.

To check out what the initial reflections can do, reduce or turn down the Decay level in the Decay parameters section and turn up Room level in the Room parameters section. Then try to change the Room size and the Room shape in the Master section and choose the combination that you like.

Then try to change the Color in the Room parameters

section to find the tonal balance that suits you.

You will hear a short spatial reverb which sounds a little like a "gated" reverb. Then at last add the decay by turning up the Decay level in the Decay parameters section and select the decay time that you prefer. You will also hear that you are able to create a very spatially wide and deep stereo reverb, with a relatively short and low level decay.

When listening to the Reverb's initial reflections alone at a high level and when selecting Room size XL, Grand or Huge, you might get a "slapback" effect, but by adding the right length and amount of decay and by balancing the Room level you will find that it will be transformed into width and depth.

Square A typical square room with its defined reflection patterns.

Round A diffuse room with lively reflections.

Curved A soft, yet still defined set of the reflections.

Room size

Sets the size of the room that the initial room reflections emulate.

It automatically changes the length of the Predelay (the time until the first reflection appears) and the Decay start (the time where the Decay tail of the Reverb starts).

The Predelay and the Decay start can be individually adjusted to another length in the Room and Decay section of the algorithm.

Box - Tiny - Small - Medium - Large - XL - Grand - Huge

The sizes: Box, Tiny, Grand & Huge are patterns emulating extreme room sizes.

Reverb level

Adjusts the combined Room level and the Decay level, and should be seen as a master level.

The Room level and the Decay can individually adjusted to another relation in the Room and Decay section of the algorithm. Range +/-50.

THE BLOCKS

High color

Sets the treble color of the decay. When Color in the Room section of the algorithm is set to Auto, it also controls the treble factor of the initial room reflections. Wool - Warm - Real - Clear - Bright - Crisp - Glass

High factor

Emphasizes or reduces the character set by the High color. Range +/-25.

Low color

Sets the Bass color of the Decay. Thick - Fat - Round - Natural - Light - Tight - Thin - No bass.

Low factor

Emphasizes or reduces the character set by the Low color. Range +/-25.

Room parameters

Adjusts the level of the initial room reflections, which is master controlled by the Reverb level.

With this control you can emphasize or reduce the initial room reflection's influence on the Reverb sound.

Range +/-50.

Color

Sets the tonal color of the initial reflections.

When set to Auto it is linked to High color

Auto - Wool - Warm - Real - Clear - Bright - Crisp - Glass.

Color factor

Emphasizes or reduces the character set by Color. Range +/-50.

Predelay

Allows adjustment of the predelay (the time until the first reflection appears) which is automatically set when choosing the Room size. Range +/-50.

Decay level

Adjusts the level of the decay, which is master controlled by the reverb level.

With this control you can emphasize or reduce the decay tail's influence on the Reverb sound. Range +/-50.

Diffuse

Allows fine tuning of the density of the decay tails. Is set automatically when choosing the desired Decay time.

Makes it possible to reduce flutter in the decay to an absolute minimum. Range +/-25.

Decay start

Allows adjustment of the decay start (the time where the Decay tail of the Reverb starts), which is set automatically when choosing the Room size.

Range +/-50.

Mix

This parameter sets the mix relation between the dry (direct) and the wet signal. If you are using G-Force as an insert effect this means that your direct signal goes through the G-Force.

In Level

Controls the input level of the block.

Out Level

Controls the output level of the Reverb block.

Mute mode

See Mute mode in the introduction of this chapter.

Simple Reverb

The Simple Reverb is based on the same algorithm as the Advanced, but the number of parameters are reduced to 5. This makes it possible for you to set up the Reverb easily and quickly

Type

Sets the type of the Reverb, meaning the size and relationship between Predelay, Early reflections and Decay automatically. (See Advanced Reverb for further explanation).

Types: Room, Club, Hall, Church, Cathedral, Grand Hall, Fast Decay, Slow Decay, Plate, Spring.

Decay time

Sets the length of the reverb decay from 0.01 - 20.0 seconds

Predelay

Allows adjustment of the predelay (the time until the first reflection appears) which is automatically set when choosing Type. Range +/-50.

Reverb level

Adjusts the combined Room level and the Decay level, and should be seen as a master level.

The Room level and the Decay can be individually adjusted to another relation in the Room and Decay section of the algorithm. Range +/-50

Color

Sets the tonal color of the initial reflections.

When set to Auto it is linked to High color

Wool - Warm - Real - Clear - Bright - Crisp - Glass - Extreme.

Mix

This parameter sets the mix relation between the dry (direct) and the wet signal. If you are using G-Force as an insert effect this means that your direct signal goes through the G-Force.

In Level

Controls the input level of the block.

Out Level

Controls the output level of the Reverb block.

Mute mode

See Mute mode in the introduction of this chapter.

Output

The Output section contains a master output level control and a set of Speaker Filters. All parameters in the Out Section are global only, which means that they are not included when you store a preset.

Level

In the Output block, you will find an overall outlevel in addition to the potentiometer on the front panel. This Outlevel can be controlled via MIDI or pedal, set up in the I/O Setup, Control display via the Main Volume parameter.

The Outlevel is not included in the preset.

Speaker Filters

The Speaker Filters are meant to roll off some high and low frequencies like a guitar cabinet would do. This will make it possible to rehearse with the G-Force on your home stereo using a preamp or pedal and a pair of headphones.

Filters

Sets the Speaker Filter On/Off.

Locut

The Locut filter cutoff frequency can be either 40 or 80Hz.

Hicut

The Hicut cutoff frequency can be 2,5kHz, 3kHz, 3,5kHz, 4kHz, 4,5kHz or 5kHz.

THE RESET PAGE

- Store and load your own default settings
- Enter User Data page
- Reset system parameters
- Clear all user presets
- Test Programs

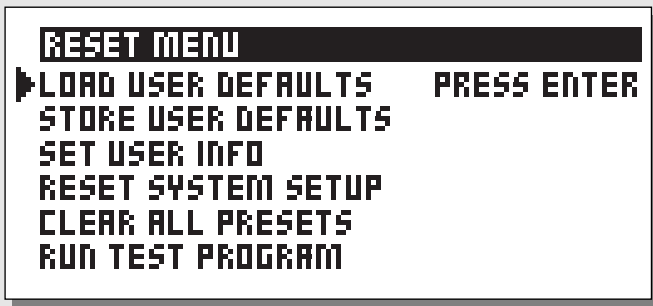

- Type your name here
- and your phone number

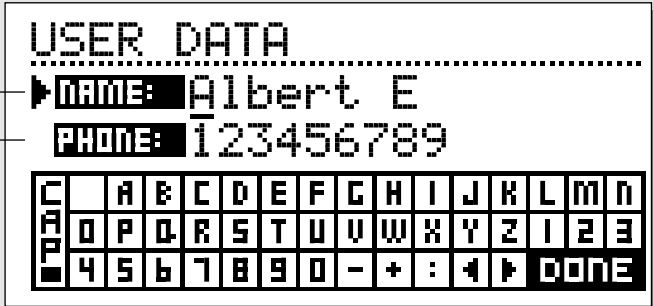

How to enter the Reset page

Hold the Overall Bypass key pressed during power-up. Move the marker using the Parameter wheel and press Enter to select the RESET type you desire.

Load User Defaults

This will reset all system parameters back to a default setup made by you (See Store User Def). This reset will NOT delete the User presets of the G-Force.

Store User Defaults

When you have the perfect setup of your G-Force, you can store this as your own default setup. This function is very useful for example when you have finished a special production and want to go back to normal. When you have the perfect setup of your G-Force, simply select this parameter and press Enter to store your default settings.

Set User Info

This function makes it possible to store your name and phone number into the G-Force. Press Enter to access the User data menu. Use the Value wheel and the Parameter wheel to write your name and phone number into the G-Force. Press Enter to accept. Your name and phone number will be displayed during power-up.

Reset System Setup

This will reset all system parameters back to the factory default. This reset will NOT delete the User presets of the G-Force.

Clear all Presets

This will delete all User presets.

Run Test Program

See description on page 53

TECHNICAL SPECIFICATIONS

Analog Inputs

Connectors:	1/4" phone jack, unbalanced (Ring: grounded)
Impedance:	1 MOhm
Max. Input Level:	+21 dBu
Sensitivity:	@ 15 dB headroom: -26 dBu to +6 dBu
A to D Conversion:	24 bit (1 bit, 128 times oversampling)
A to D Delay:	0,9 ms @ 44.1 kHz
Dynamic Range:	>105 dB
THD:	0.003% @ 1 kHz, 6 dB below full scale
Frequency Response:	+0/-0.5 dB (20 Hz - 20 kHz)
Crosstalk:	<-60 dB (20 Hz - 20 kHz)

Analog Outputs

Connectors:	1/4" phone jack, balanced
Impedance:	100 Ohm (active transformer)
Max. Output Level:	+22 dBu
Full Scale Output Range:	-10 dBu to +22 dBu
D to A Conversion:	24 bit (1 bit, 128 times oversampling)
D to A Delay:	0.6 ms @ 44.1 kHz
Dynamic Range:	>100 dB
THD:	0.005% @ 1 kHz, 6 dB below full scale
Frequency Response:	+0/-0.5 dB (20 Hz - 20 kHz)
Crosstalk:	<-60 dB (20 Hz - 20 kHz)

Digital Inputs and Outputs

S/PDIF In/Out:	Coaxial, RCA Type
Formats:	EIAJ CP-340, IEC 958, S/PDIF (24 bit)
Sample Rate:	44.1 kHz

PCMCIA Interface

Connector:	PCMCIA Type 1 cards
Standards:	PCMCIA 2.0, JEIDA 4.0
Card Format:	Supports up to 2 MB SRAM

Control Interface

MIDI:	In/Out/Thru: 5 Pin DIN
External control:	1/4" phone jack

General

Finish:	Anodized aluminum face. Plated and painted steel chassis
LED:	3 LED meters, 5 x 14 dot LED-matrix
LCD:	56 x 128 dot graphic LCD-display
Dimensions:	19" x 1.75" x 8.2" (483 x 44 x 208 mm)
Weight:	5.0 lb. (2.25 kg)
Mains Voltage:	100 to 240 VAC, 50 to 60 Hz (auto-select)
Power Consumption:	<20 W
Backup Battery Life:	>10 years

EMC

Complies with:	EN 55103-1, EN 55103-2 and Class B limits of FCC rules, part 15
----------------	--

Safety

Certified to:	EN 60065, UL 1419
---------------	-------------------

Environment

Operating Temperature:	32 °F to 122 °F (0 °C to 50 °C)
Storage Temperature:	-22 °F to 167 °F (-30 °C to 70 °C)
Humidity:	Max. 90% non-condensing

NOTE: Due to continuous development and standardization all specifications are subject to change without notice

TROUBLESHOOTING

You are not getting any sound through the G-Force when you bypass it.

- You selected Killdry ON, in the I/O Setup, Audio menu.

You press Power switch, but there is no reaction.

- The power switch on the rear panel is switched off.

You can not turn the power off.

- Press and hold the Power switch for 3 seconds, then release to power off

No sound through the G-Force.

- You are using Analog input, but the input selector in I/O Setup, Audio menu is set to Digital.

The sound is phasing with your direct signal.

- You are running the G-Force in a parallel setup, but the killdry function in I/O Setup, Audio menu is set to Off.

Right input meter is not showing any signal.

- You selected L-Only in the I/O Setup, Audio menu.

Effects only in the Left Output

- You are only using Left input, but the Input selector in I/O Setup is set to Stereo.

Your Expression pedal does not work properly

- Be sure the G-Force is set to the correct pedal type and the pedal is calibrated correctly in the Utility menu.

MIDI IMPLEMENTATION CHART

EFFECTS PROCESSOR G-Force - May 23 th, 1997 Version 1.0

Function		Transmitted	Recognized	Remarks
Basic Channel	Default	1	1	
	Changed	1-16	1-16	
Mode	Default			
	Messages	X	X	
	Altered			
Note Number		X	O	
	True Voice	X	X	
Velocity	Note ON	X	X	
	Note OFF	X	X	
After Touch	Key's	X	O	
	Ch's	X	X	
Pitch Bend		X	O	
Control Change		0-127	0-127	
Prog Change		O	O	
	True#	0-127	0-127	
System Exclusive		O Bulkdump	O Bulkdump	
Common	:Song Pos	X	X	
	:Song Sel	X	X	
	:Tune	X	X	
System real time	:Clock	X	X	
	:Commands	X	X	
Aux Messages	:Local ON/OFF	X	X	
	:All Notes OFF	X	X	
	:Active Sense	X	X	
	:Reset	X	X	

Notes

O:YES

X:NO

SELF TEST

PRESS THE BYPASS KEY, WHILE POWERING UP, TO ACCESS THE SELF-TEST AND SELECT »RUN TEST PROGRAM«

Turn the Value Wheel to scroll through Self tests

Key test

Select Key test by pressing Enter.

The keys must be pressed in the order they are requested by the G-Force to pass the test.

Press Exit to leave Key test.

In/Out knobs test

Select In/Out knobs test by pressing Enter.

Turn the In/Out knobs to 30 and back to 0 to pass test.

Press Exit to leave In/Out test.

Parameter + Value Wheel test

Select test by pressing Enter.

Turn the Value and Parameter wheel to 30 and back to 0 to pass test. Press Exit to leave Adjust Wheel test.

LED test

Select LEDs test by pressing Enter.

Turn Adjust Wheel to test the LEDs. The test is "ok" when none Leds are lit.

Press Exit to leave Led test.

Display test

Select Display test by pressing Enter.

Press Enter to check that all pixels are lit. Press any key to leave the pixel test.

Press Exit to leave Display test.

Analog I/O test

Select Analog I/O test by pressing Enter.

Connect an Analog Output to the Analog Input, which has to be tested and press Enter.

PPM must show -12 dB to pass test.

Press Exit to leave Analog I/O test.

Digital I/O test

Select Digital I/O test by pressing Enter.

Connect a Digital Output to the Digital Input, which has to be tested and press Enter.

The AES/EBU output can also be connected to the S/PDIF input and vice versa.

PPM must show 0 dB to pass test.

Press Exit to leave Digital I/O test.

MIDI I/O test

Select Midi I/O test by pressing Enter.

Connect Midi Out to Midi In.

Prg change 1-128 is send out on Midi Thru. Connect this socket to a Midi compatible device and confirm the Prg. changes.

Press Exit to leave Midi I/O test.

Pedal socket test

Select Pedal test by pressing Enter.

Connect a momentary pedal to the Pedal socket.

When pressing the Pedal, the Result should be OK.

When released, the Result should be Not OK.

Press Exit to leave Pedal test.

NOTE: Result of test must be OK if no jack is inserted.

PCMCIA test

Select PCMCIA test by pressing Enter.

Insert PCMCIA card. Note that all Data on PCMCIA card will be destroyed.

Press Enter to test.

Result reads:

Low battery - Time to change battery in your PCMCIA card.

Not OK - Try the test using another PCMCIA card.

Press Exit to leave PCMCIA test.

Battery test

Select Battery test by pressing Enter.

Confirm that Result is OK.

Press Exit to leave Battery test.

System test

Select System test by pressing Enter.

Confirm that Result is OK.

Result reads:

Eeprom Not OK - The unit will most likely work OK, the message is for service matters only.

DSP Not OK - Contact your local dealer.

Press Exit to leave System test.

Power Off - On to start standard software.

Build in test v.2.07

PRESET LIST

1	Mono Reverb	Clean / Dirty		A straight Reverb preset suitable for any mono setup.	Mono
2	Mono Chorus	Clean / Dirty		A straight Chorus preset suitable for any mono setup.	Mono
3	Mono Dyn Delay	Clean / Dirty		A Dynamic Delay preset suitable for any mono setup. Input level independent.	Mono
4	Mono Harmony C-Maj	Clean / Dirty		A preset with Intelligent Pitch-shift in C-major suitable for any mono setup.	Mono
5	Mono Doubler	Clean / Dirty		A Detuned setting producing a doubler effect suitable for any mono setup.	Mono
6	Mono Tremolo	Clean / Dirty		A straight Tremolo preset suitable for any mono setup.	Mono
7	Mono Touchwah	Clean / Dirty		A straight Touch Wah preset suitable for any mono setup.	Mono
8	Mono Phaser	Clean / Dirty		A straight Phaser preset suitable for any mono setup.	Mono
9	Mono Crank It Up	Clean / Dirty		A slightly cranked setting suitable for any mono setup.	Mono
10	Mono Pedal Delay	Clean / Dirty	X	Pedal to toe feeds the Delay input. Suitable for any mono setup.	Mono
11	Mono Pedal Pitch	Clean / Dirty	X	Pedal adds a lower octave. Suitable for any mono setup.	Mono
12	Mono Farout Phaser	Clean / Dirty		A Phaser with an LFO controlled speed, really weird. Suitable for any mono setup.	Mono
13	Stereo Reverb	Clean / Dirty		A straight Reverb preset suitable for any stereo setup.	Stereo
14	Stereo Chorus	Clean / Dirty		A straight Chorus preset suitable for any stereo setup.	Stereo
15	Stereo Wide Panner	Clean / Dirty		A Panner that pans beyond a normal stereo image.	Stereo
16	Stereo Dyn Delay	Clean / Dirty		A Dynamic Delay preset suitable for any stereo setup. Input level independent.	Stereo
17	Stereo Harmony C-Maj	Clean / Dirty		A preset with Intelligent Pitch-shift in A-major suitable for any stereo setup.	Stereo
18	Stereo Doubler	Clean / Dirty		A Detuned setting producing a doubler effect suitable for any stereo setup.	Stereo
19	Stereo Light Tremolo	Clean / Dirty		A subtle Tremolo preset suitable for any stereo setup.	Stereo
20	Stereo Summers Strum	Clean / Dirty		Great chorused, shimmery doubler, delay and reverb similar to sound used by ex- Police guitarist.	Stereo
21	Stereo Clean Lead	Clean / Dirty		A clean preset with detuned pitch and chorus.	Stereo
22	Stereo Crank It Up	Clean / Dirty		A slightly cranked setting suitable for any stereo setup.	Stereo
23	Stereo Touchwah	Clean / Dirty		An input sensitive Wah preset suitable for any stereo setup.	Stereo
24	Stereo Pedal Delay	Clean / Dirty	X	Pedal feeds the Delay input. Suitable for any stereo setup.	Stereo
25	Stereo Pedal Pitch	Clean / Dirty	X	Pedal adds a lower octave. Suitable for any mono setup.	Stereo
26	3-Way Reverb	Clean / Dirty		A straight Reverb preset suitable for any 3-way or parallel setup.	3-Way
27	3-Way Chorus	Clean / Dirty		A straight Chorus preset suitable for any 3-way or parallel setup.	3-Way
28	3-Way Delay Doubler	Clean / Dirty		A short delay making a doubler effect suitable for any 3-way or parallel setup.	3-Way
29	3-Way Slap+Slow Dly	Clean / Dirty		A simultaneous slapback delay plus long delay suitable for any 3-way or parallel setup.	3-Way
30	3-Way Dyn Delay	Clean / Dirty		A Dynamic Delay preset suitable for any 3-way or parallel setup. Input level independent.	3-Way
31	3-Way Harmony A-maj	Clean / Dirty		A preset with Intelligent Pitch-shift in A-major, suitable for any 3-way or parallel setup.	3-Way
32	3-Way Doubler	Clean / Dirty		A Detuned setting producing a doubler effect, suitable for any 3-way or parallel setup.	3-Way
33	3-Way Lead Octave up	Clean / Dirty		Adds an octave higher voice to your lead sound. Suitable for any 3-way or parallel setup.	3-Way
34	3-Way Panner	Clean / Dirty		A subtle slow panning effect. Suitable for any 3-way or parallel setup.	3-Way
35	3-Way LA's Favored	Clean / Dirty		An LA like lead sound, suitable for any 3-way or parallel setup.	3-Way
36	3-Way Pedal Reverb	Clean / Dirty	X	Pedal controls the level of the Reverb. Suitable for any 3-way or parallel setup.	3-Way
37	3-Way Pedal Octaver	Clean / Dirty	X	Pedal adds an octave voice to your sound. Suitable for any 3-way or parallel setup.	3-Way
38	Go Direct	Clean		EQ & Compression.	Rhythm
39	Clean Rhythm Room	Clean		Short room and a touch of Chorus.	Rhythm
40	Clean Notes n Chords	Clean / Dirty	X	Rhythm type preset. Pedal is attached to volume.	Rhythm
41	Garden Party	None		Dark, earthy, big-bodied acoustic guitar sound.	Rhythm
42	Love and Affection	None		Lush, compressed, organic sounding and lightly chorused. Plug your acoustic in direct and go.	Rhythm
43	Arpeggiators Dream	Clean / Dirty		A Vibrato-like Chorus + Compression, optional Reverb.	Rhythm
44	Power Chord	Driven		Optimized for power chords, with some flanging thrown in. Drive is ready to go.	Rhythm
45	For Acoustic Guitar	None		Set for high-end Acoustic direct into input.	Rhythm
46	Troubadour	None		Great solo acoustic sound, very pure, punchy and tight. Great for sitting properly in recorded tracks.	Rhythm
47	Sunset Groove	Driven		Out of phase, dominant sound. VERY articulate. Great for muted heavy rhythm/picking style.	Rhythm
48	Lipstick Color	Clean/Dirty	X	A tight, fat effect great for giving space to staccato rhythm guitar.	Rhythm
49	Nice Chorus	Clean / Dirty		A straight sine Chorus effect in combination with a hall-like Reverb.	Rhythm
50	Lush Chorus	Clean		Lush Chorus setting, good for coloring a clean sound.	Rhythm
51	Double Jeopardy	Clean / Dirty		A slapback Delay and a room Reverb.	Rhythm
52	Tone Girdle	Clean / Dirty		Compressor with optional EQ and Doubler.	Rhythm
53	Phat Chorus	Distorted		EQ + Chorus.	Rhythm
54	Crowded House	Clean / Dirty		A bright rhythm sound with a slap Delay and a reverb.	Rhythm
55	Captain Crunch	Heavy OD		Death Metal Stereo Detuning with a little slap added. Try this one on Metallica's "Enter Sandman"	Rhythm
56	Rockabilly Boogie	Driven		Classic 50's echo sound, set to emulate the time delay on a standard reel-to-reel recorder.	Rhythm
57	Thick Ducktape Delay	Clean / Dirty		Detuned, warm, ducked Delays. Input level dependent.	Rhythm
58	Slap Back Delay	Clean/Dirty		Pretty much what the title says.	Rhythm

PRESET LIST

59	A Little Bit Country	Clean		Howdy, check out this preset with a Ultra clean and bright sound.	Rhythm
60	On The Edge	Clean / Dirty		U2 inspired Delays like on "Where The Streets Have No Name".	Rhythm
61	A Clean Fortress	Clean		Sting's "Fortress Around Your Heart" or Andy Summer's sound on "Every Breath You Take".	Rhythm
62	Gated Delay	Clean / Dirty		The Delay plays with you, but not without you.	Rhythm
63	60's Flanging	Clean / Dirty		Actually Flanges through zero by delaying the straight signal though the Delay block in parallel.	Rhythm
64	Funky Chorus	Clean		Good for R&B on a clean setting.	Rhythm
65	Flange Yer Face	Clean / Dirty		All purpose Flanger, great for guitar and vocal effects. Super for acoustic guitar.	Rhythm
66	Dream Phaser	Driven		Ambient, spacey, stereo Phase-Shifting sound.	Rhythm
67	Churner	Clean		Slow sweeping resonant Flanger, Phaser with Chorus, Pitch Detune and slap Delay into small Room.	Rhythm
68	Stereo Tremolo	Driven		A simple Tremolo, but opposite in left and right.	Rhythm
69	Beatle Chords	Clean	X	Pedal to heel = Stereo guitar / Pedal to toe = Fast rotating cabinet effect.	Rhythm
70	Phased Tremolo	Clean		Great for folk ballads or Tex-Mex tunes on clean setting. Heavy on Tremolo.	Rhythm
71	In My Room	Clean		Clean surf guitar sound reminiscent of Beach Boys' ballads, The Surfaris or The Ventures.	Rhythm
72	Spin Off	Clean / Dirty	X	Rotary effect. Use Ext. 1 to control the speed.	Rhythm
73	Vibropedal Room	Clean / Dirty	X	Fast Vibrato from Chorus with dual detune and room reverb. Pedal slows Vibrato and lowers Reverb.	Rhythm
74	Tremolo + Reverb	Clean / Dirty		Pretty straight preset with a classic Tremolo and a Hall.	Rhythm
75	Day at the Beach	Clean	X	Pedal to heel = Surfers dream / Pedal to toe = Tremolo.	Rhythm
76	Spinner	Clean / Dirty	X	Pedal to hell = Direct guitar / Pedal to toe = Spinning guitar.	Rhythm
77	Wahble Gatelike	Clean / Dirty	X	A fast Wah Filter into a Chorus and Gate-like reverb, good for anything funky. Pedal to heel lowers Wah.	Rhythm
78	Filterfun Funkypick	Clean		Envelope controlled fast downward-sliding Wah Filter with slow rise time + some Chorus and a small Reverb Hall.	Rhythm
79	Park the Wah Here	Driven	X	A parked Wah effect. Sounds like Dire Strait's "Money for Nothing", or Boston's "Long Time".	Rhythm
80	Tube Scream	Clean	X	Pedal to heel = Clean rhythm sound, Pedal to toe = Vintage Tube screamer + Room.	Rhythm
81	Raunchy Rhythm	Clean		Basic grunge rhythm guitar patch.	Rhythm
82	Malcolm	Clean		Great rhythm sound, useful with multiple guitar players in one band. Great overall rock/blues sound.	Rhythm
83	Rubbery Room	Clean	X	Smooth Drive fuzz with dynamic Chorus, smooth Phaser, a Detuner and a nice Room. Good for comping Chord work.	Rhythm
84	Crunch Phasecomp	Clean	X	A thick, fuzzed and phased effect, good for choppy comping chords.	Rhythm
85	Fuzzphaser Pedal	Clean		Pedal controls the amount of low end. Set pedal to toe for thin fuzzed sound.	Rhythm
86	A Little Crunch	Clean		Feed the G-Force with a clean setting, and have a little crunch. Good for rhythm.	Rhythm
87	Loose Tubes	Clean		Gives you that crunch with a loose bottom that you know from older tube amps. Good for rhythm.	Rhythm
88	Les is Paul	Clean		Gets that mid-rangy sound. Great rhythm sound.	Rhythm
89	Yee Ha	Clean	X	Compressed Country twang.	Lead
90	Flange Box	Clean/Dirty		Slow semi-resonant Flange in a very small "box" like reverb. Good for distorted chunks.	Lead
91	Flanger In Verb	Clean/Dirty		Slow rolling Flanger with feedback.	Lead
92	Surround Reverb	Clean		Slow moving reverb. Great for clean ballad leads.	Lead
93	Guitar Hero	Major OD		Steve Lukather, Mike Landau, Dan Huff. Think big 80's sound. Add major solo overdrive.	Lead
94	Landau Clean	Clean		LA studio session player's clean sound.	Lead
95	Ballad Clean	Clean		Smooth, pretty, Clean Shaven !!	Lead
96	Ed Now and Then	Heavy OD		Van Halen Present = Pitch-shift / Past = Phaser. Select either Pitch or Filter effect button for era.	Lead
97	So Stern	Clean		Inspired by Miles Davis' guitarist Mike Stern. Jazzy Ultra "Womanizer" effect.	Lead
98	LA Studio Rack	Clean / Dirty		A bright "LA-like" lead preset. Optional Pitch octave up.	Lead
99	Straight Lead	Clean / Dirty		An all purpose preset ready for pop leadlines.	Lead
100	Lead	Clean / Dirty		A nice tail of Delay and Reverb.	Lead
101	Westcoast Lead	Clean / Dirty		A bit of Delay reverb and chorus. Add a crunchy tone and enjoy the California feel.	Lead
102	Fusionlead	Clean		A Chorused lead sound inspired by guys like Mike Stern.	Lead
103	Clean Chorused Delay	Clean / Dirty		A Reverb and Chorused Delay that will Chorus only your long notes.	Lead
104	Clean Ducked Swell	Clean		Dynamic Delays.	Lead
105	Echocomplex	Clean / Dirty		The classic dull sound of an Echoplex with a slight moving detune to create flutter.	Lead
106	Pedal Feed Delay	Clean / Dirty	X	Pedal to heel = no Delay / Pedal to toe = feeds the Delay input.	Lead
107	Final Frontier	Clean		Good for dream like application on clean sound.	Lead
108	Wishey Wash Tap	Clean / Dirty		Fast subtle Phaser into detune and Dly/Verb wash + Chorus. Good for clean chords, fuzzed lead.	Lead
109	Twang Slap	Dirty	X	Feed with a dirty setting. Chorus and a Delay slap makes it wide and full. Good for rhythm.	Lead
110	Answering Echo	Clean / Dirty		Bryan May in Brighton Rock or Steve Vai on David Lee Roth's "Skyscraper" album.	Lead
111	Wes M Jazz Lead	Clean	X	For Octave lead jazz lines a la Wes Montgomery.	Lead
112	Low Note Thicken	Clean		Pedal to heel = shimmering rhythm guitar / Pedal to toe = Added low octave.	Lead

PRESET LIST

113	Pitch -12 and -5	Dirty	X	Pedal to heel = Straight clean sound / Pedal to toe = two voice Pitch-shifting -12 and -5.	Lead
114	C+W Diaton Solo in A	Clean / Dirty		Play single-note runs for instant twangy Georgian C&W harmonies. Works best on higher strings.	Lead
115	Eats Your Attack	Clean / Dirty		Envelope controlled input volume. Will perform the Volume knob trick automatically.	Lead
116	Pedal Octave Down	Clean / Dirty	X	Pedal performs a Whammy down when set to heel.	Lead
117	Pedal Octave Up	Clean / Dirty	X	Pedal performs a Whammy up when set to toe.	Lead
118	Pitch Dm 5 and 3	Clean / Dirty		Single note lead. Play in D-minor with a third and a fifth added.	Lead
119	Pedal Add Octave Up	Clean	X	Pedal to heel = crunchy lead sound, Pedal to toe = adds an octave voice.	Lead
120	Flanger Beautyverb	Clean		Dense, thick reverb with medium long decay through a slow flanger. Good for leads and chords.	Lead
121	Verb Morphed to Dly	Clean / Dirty		An Envelope controlled crossfade between Reverb and Delay. Reverb when you play, Delay when you stop.	Lead
122	I've Been Drinking	Distorted	X	Pedal to heel = Phased guitar / Pedal to toe = Room spinning.	Lead
123	Panner Pedal	Clean / Dirty	X	Pedal pans from left to right.	Lead
124	Picking Style	Clean / Dirty		Input sensitive parallel Wah Filter, great for picking guitar.	Lead
125	Envelope Filter	Clean / Dirty		Envelope Filter effect. Input level threshold dependent.	Lead
126	Nervosa Doubler	Clean / Dirty		Fluttery Phaser and Panning with Chorus and Pitch-shifter doubles. Good on both lead and chords.	Lead
127	Blues Room	Clean		Nice for blues.	Lead
128	Hammer to Fall	Clean		Totally dominant distorted main rhythm guitar sound, inspired by the famed Queen song.	Lead
129	Iron Man	Clean		The Ultimate power chord sound. Metallica, saturated, ominous. Check the title, need we say more?	Lead
130	Thick'n Juicy Lead	Clean		Nice greasy lead.	Lead
131	Smooth Tubedrive	Clean		Gives you that drive with a loose bottom that you know from older tube amps. Good for lead.	Lead
132	Duckman Lead	Clean / Dirty		Quacks like a duck, thanks to a Wah-Wah. Brings back the 70's.	Lead
133	Lead Pedal Wah	Clean	X	Feed the G-Force with a clean tone and Wah away with your pedal. Great for leads.	Lead
134	Touch Wah Driven	Clean		Feed the G-Force with a clean tone and Wah away with your picking power. Great for leads.	Lead
135	Pedal liaahh	Dirty	X	Feed the G-Force with a dirty tone and talk away with your pedal. Very special lead sound.	Lead
136	Driven Lead	Clean		Overdriven lead sound with an octave shifter feed into a big hall.	Lead
137	Octavia Lead	Clean		Works well on distortion setting for wild "Yes" type solos.	Lead
138	The Smiths	Clean		Wide tremolo sound on top of a punchy distorted sound. Inspired byguess who!	Wacky
139	Cyber Sci-fi Surfer	Clean		Fast Panning Chorus, sweeping Phaser and Pitch-shifter doubles into filtered slap Delays and very small Reverb.	Wacky
140	Steppers in Time	Clean / Dirty		Stepped Formant Filter that steps in time with repeating Delays. Play along with Delay time for best effect.	Wacky
141	Spaceyplace	Clean / Dirty	X	Slow echoes and a big Reverb. Pedal controls Phaser level.	Wacky
142	Bluebox Echophased	Clean		The kitchen sink, full fuzz, deep Phaser, pitch at -12 and -5, panned echo and Chorus. Good on leads.	Wacky
143	Echoverb	Clean / Dirty		Smooth chorus, echo + a long hall Verb makes you sound like an ECM artist.	Wacky
144	Duality Effects	Clean / Dirty	X	Two separate effect chains. Pedal controls the speed and level of the Phaser.	Wacky
145	Bowling Multitaps	Clean / Dirty		Play melodically in time with the echoes for fun and turn on the Drive for a fuzzed sound.	Wacky
146	Slow Swell Pad	Clean / Dirty		Dreamy "attack free" sound designed for slow chord or melody passages. Input level dependent	Wacky
147	Expandelay	Clean / Dirty		First four repeats become increasingly louder before subsequent repeats decrease in volume.	Wacky
148	Infinity and Beyond	Clean / Dirty	X	Long Reverb and Delays.	Wacky
149	Deep Bass 9	Clean		Highly compressed bass sound, designed for ambient/Techno/TR303 emulation.	Wacky
150	Flange Pedal Speed	Clean / Dirty	X	Pedal controls the speed of the Flanger.	Wacky
151	Duck on Crack	Distorted	X	Pedal to heel = Moderately normal guitar / Pedal to toe = Dynamically contr. duck (1 Octave up).	Wacky
152	Sus4 Dreamscape	Clean / Dirty		Dual Shifters add a fourth and a fifth creating a sus4 chord with lots of Chorus, Delay and Reverb	Wacky
153	Crazy Brown Lead	Clean / Dirty		Sounds best on leads. Shifter adds Octave up and down with a crazed Pan and Phaser. Dynamic Delay.	Wacky
154	Eastern Ocean	Clean / Dirty	X	Dual shifters at a 5th and octave above feed into a chorus + a very wet long Reverb. Good for slow leads.	Wacky
155	Skysaw Doubler	Clean	X	Crashy fuzz into dual Pitch-shifters set an octave up with sweeping high feedback Flanger. Great for leads.	Wacky
156	Synthesized Leads	Clean		Fuzz, pitched an octave up and down into Compressor with Touchwah and slap Delays. Good on soft leads.	Wacky
157	Sexwah Pedalead Fuzz	Clean	X	A complex distorted effect with an octave + a fifth feeding a Chorus and some tap Delays. Pedal controls the Formant filters.	Wacky
158	Industrial Mayhem	Clean / Dirty		Touchwah and a low octave shifter. Input level dependent.	Wacky
159	Electric Church	Clean / Dirty		Removes your attack. Sounds very synth-like.	Wacky
160	Trance Yer Ass Off	Clean / Dirty	X	For single note lines. Use Ext. 1 to morph from Flanger to Detuned Octaver to Touchwah and vice-versa.	Wacky

PRESET LIST

161	Owner Solo	Clean / Dirty		Creates a guitar synth-like texture for over-the-top soloing.	Wacky
162	Double Fridge Solo	Clean / Dirty		If you weren't using the G-Force, you might need two racks of gear to create this sound.	Wacky
163	Tribute 2 Bootsy	Clean		Funky bass rig.	Wacky
164	War of the Worlds	Clean / Dirty		Play single note melodies to create instant cheesy Sci-fi tones.	Wacky
165	Inside Out Dyn Pan	Clean / Dirty		Slow Panner speeds up as signal fades.	Wacky
166	Far Away Vibrato	Clean / Dirty		You're sitting far away with your Vibrato sound.	Wacky
167	Dynamic Lesley	Clean / Dirty		Spins fast with louder signals.	Wacky
168	Varispeed Phaser	Clean / Dirty		This Phaser changes speed all the time.	Wacky
169	Dark Envelope Filter	Clean / Dirty		Compressed Envelope-Filtered Reverb. Input level dependent.	Wacky
170	Touch Wah + Octave	Clean / Dirty		Pretty much what the name says. One octave up and a Touchwah.	Wacky
171	Who's Next.	Clean / Dirty		Square Tremolo and an Autowah.	Wacky
172	Broken Speaker	Clean / Dirty		Transistor radio guitar.	Wacky
173	Touch Res and Delay	Clean / Dirty	X	An input level dependent Resonance Filter and some Delay.	Wacky
174	Jam With Loop	Clean / Dirty	X	Create a 1000ms loop and jam over it. Ext. 1 controls the looping, Ext. 2 controls the adding of the loop/ playing on top of the loop.	Wacky
175	Pedal Hold + Reverb	Clean / Dirty	X	Strike a chord, move the pedal to toe, and you have a nice background to play on.	Wacky
176	Very Scary Horror	Clean / Dirty	X	Push the pedal back and forth while playing, but watch out for the Demons.	Wacky
177	Talking Whales	Clean / Dirty	X	Push your pedal gently while playing long sustaining notes and listen to the talking whales.	Wacky
178	Flyverb Ducker	Clean / Dirty		Heeeellllp meeee!! A fly caught in the sound! Chorused doubled sound into long Reverb, shifted an octave and into Phaser. Good leads.	Wacky
179	Chord Stabs	Driven	X	Pedal to heel = Mono guitar signal / Pedal to toe = Stereo octave up.	Wacky
180	Bright Room	Clean / Dirty		A single block with an all-purpose Reverb Room.	Block
181	Church	Clean / Dirty		A single block with an all-purpose Church Reverb.	Block
182	Grand Hall	Clean / Dirty		A single block with an all-purpose Grand Hall Reverb.	Block
183	Cathedral	Clean / Dirty		A single block with an all-purpose Cathedral Reverb.	Block
184	Spring Reverb	Clean / Dirty		A single block with an all-purpose Spring Reverb.	Block
185	Slow Reverb	Clean / Dirty		A single block with an all-purpose slow-reacting Reverb.	Block
186	Chorus Straight	Clean / Dirty		A single block with an all-purpose straight Chorus.	Block
187	Chorus Straight Fast	Clean / Dirty		A single block with an all-purpose straight Chorus a bit faster.	Block
188	Flanger Straight	Clean / Dirty		A single block with an all-purpose straight Flanger.	Block
189	Flanger Straight Fast	Clean / Dirty		A single block with an all-purpose straight Flanger a bit faster.	Block
190	Vibrato	Clean / Dirty		A single block with an all-purpose Vibrato (100% Chorus).	Block
191	Classic Tremolo	Clean / Dirty		A single block with an all-purpose Classic Tremolo.	Block
192	Stereo Tremolo	Clean / Dirty		A single block with an all-purpose Tremolo, opposite in left and right.	Block
193	Square Tremolo	Clean / Dirty		A single block with an all-purpose Square Tremolo also known as transforming.	Block
194	Stereo Pan Tap Tempo	Clean / Dirty		A single block with an all-purpose Panner. Tap the tempo that you want.	Block
195	Surround Panner	Clean / Dirty		A single block with an all-purpose Panner that pans past normal stereo image.	Block
196	Straight Delay	Clean / Dirty		A single block with an all-purpose 500ms Delay.	Block
197	Two Delays	Clean / Dirty		A single block with an all-purpose Delay. Left = 500ms / Right = 400ms.	Block
198	Tape Delay	Clean / Dirty		A single block with an all-purpose Highcut Filtered Delay, like an old tape Delay.	Block
199	Triplet Ping-Pong	Clean / Dirty		A single block with an all-purpose Ping-Pong Delay.	Block
200	4 Tap Delay Pedal	Clean / Dirty		A single block with an all-purpose 4-tap Delay. Pedal controls the mix level of the Delay.	Block
201	Dynamic Delay	Clean / Dirty		A single block with an all-purpose Delay. Input level dependent, plays when you stop playing.	Block
202	Soft Compressor	Clean / Dirty		A single block with an all-purpose Soft Compressor.	Block
203	Hard Compressor	Clean / Dirty		A single block with an all-purpose Hard Compressor.	Block
204	Limitter	Clean / Dirty		A single block with an all-purpose Limiter.	Block
205	Dual Detune Pedal	Clean / Dirty	X	A single block with an all-purpose Pitch Detune setting. Pedal controls the detuning of Voice 1.	Block
206	Whammy Down	Clean / Dirty	X	A single block with an all-purpose octave down Pitch-shifter. Pedal controls the pitch.	Block
207	Whammy Up	Clean / Dirty	X	A single block with an all-purpose octave up Pitch-shifter. Pedal controls the pitch.	Block
208	G-major Pitch Pedal	Clean / Dirty	X	A single block with an Intelligent Pitch-shifter set for G-major. Pedal controls the level of the third.	Block
209	D-minor 5 and 3	Clean / Dirty		A single block with an Intelligent Pitch-shifter set for D-minor with a fifth and a third added.	Block
210	Octave Dubbing	Clean / Dirty		A single block with an Octave down Pitch-shift.	Block
211	Phase Off	Clean / Dirty		A single block with an all-purpose Phaser.	Block
212	Phaser Pedal Speed	Clean / Dirty	X	A single block with another all-purpose Phaser. Pedal controls the speed of the Phaser.	Block
213	Clean Wah Pedal	Clean / Dirty	X	A single block with an all-purpose Wah Wah. Pedal controls the Wah frequency.	Block
214	Clean Touch-Wah	Clean / Dirty		A single block with an all-purpose Touchwah. Input level dependent.	Block
215	Clean Auto Wah	Clean / Dirty		A single block with an all-purpose Autowah. An external LFO controls the Wah frequency.	Block
216	Formant Touch	Clean / Dirty		A single block with an all-purpose touch-sensitive Formant Filter. Input level dependent.	Block
217	Formant Pedal	Clean / Dirty	X	A single block with an all-purpose Formant Filter. Pedal controls the Formant frequency.	Block
218	Resonance Pedal	Clean / Dirty	X	A single block with an all-purpose Resonance Filter. Pedal controls the Resonance frequency.	Block

PRESET LIST

219	Auto Resonance	Clean / Dirty	A single block with an all-purpose Auto-Resonance Filter. An external LFO controls the Resonance filter.	Block
220	Drive 1	Clean / Dirty	A single block with an all-purpose Drive.	Block
221	Drive 2	Clean / Dirty	A single block with an all-purpose Drive.	Block
222	Drive 3	Clean / Dirty	A single block with an all-purpose Drive.	Block
223	Noise Gate Slow	Clean / Dirty	Pretty much what the title says.	Block
224	Noise Gate Slow	Clean / Dirty	Pretty much what the title says.	Block
225	Empty Routing	Clean / Dirty	An Empty Routing, good for beginning building your own presets.	Block