



SPA-VIAGGIO

.....



ON: ,

OFF: ,

1.

*

*

*

*

*

*

.....

*

*

*

*

*

*

*

*

2,

SPA-VIAGGIO -

SPA-VIAGGIO

SPA-VIAGGIO :

*

* 1

* 1

* 1

* 1

*

SPA-VIAGGIO

(5)

SPA-VIAGGIO

3.

1.

2.

200 RMS

3.

D.

4.

100 (.) X 60 (.)

5. 8-

()

6.

7.

36

8.

4.

1.

2.

(1)

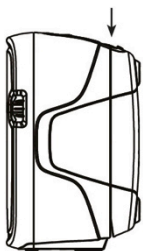

(2)

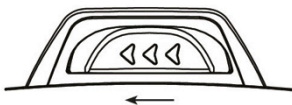

(3)

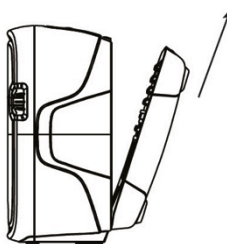

(EX.1)

3.



4.

1/4

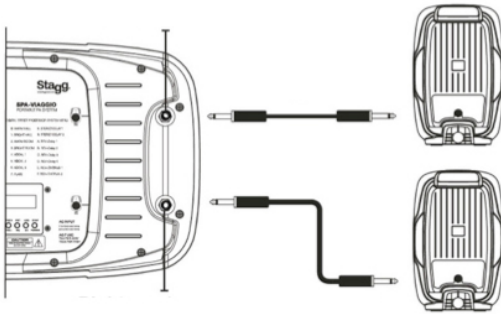

5.

POWER.

"on" ().

(Master Volume) 0.

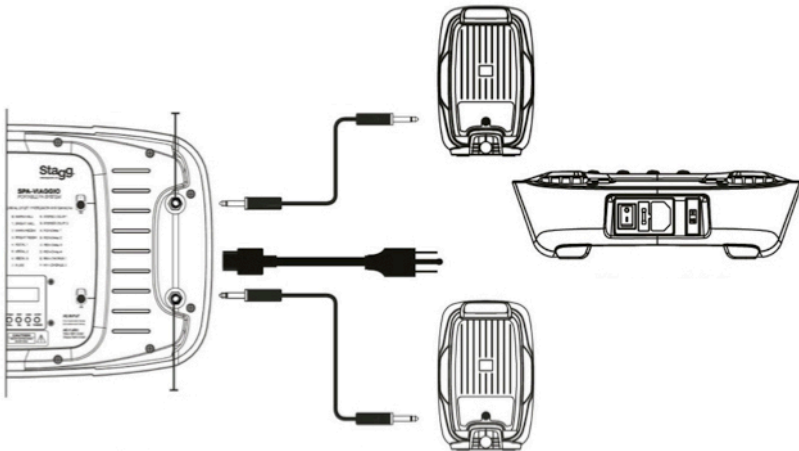

- SPA-VIAGGIO

SPA-VIAGGIO

(, MP3 CD),

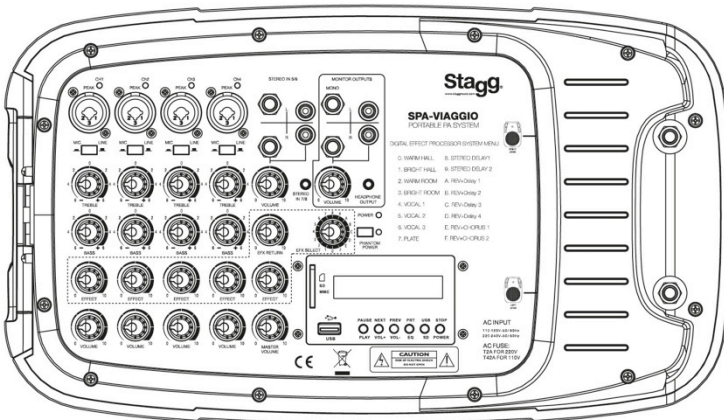

SPA-VIAGGIO 8 : 4 2 .

/

4

()

/ ,

Treble () Bass (),

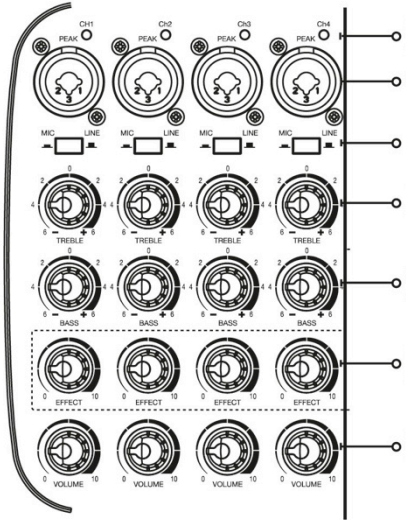

PEAK ()

()

XLR- 1/4

MIC/LINE (XLR) (1/4")

TREBLE

BASS

EFFECT

VOLUME

SPA-VIAGGIO
MP3 CD

"STEREO IN 5/6"

1/4" RCA,
STEREO IN 7/8"

3,5

1/4"

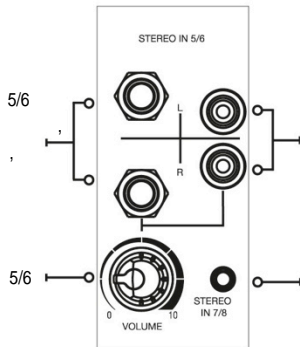

RCA 5/6 (CD MP3)

7/8, 3,5

SPA-VIAGGIO

1. LEFT/RIGHT (/) SPA-VIAGGIO,

(, SPA-VIAGGIO).

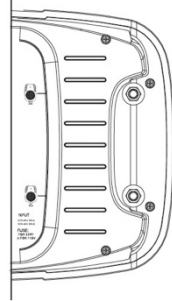

2. (Monitor out)

1/4", RCA.

MONITOR OUTPUT VOLUME - -

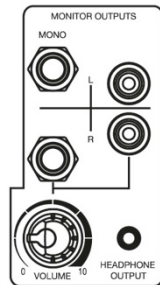

3. (headphone out)

SPA-VIAGGIO.
3,5

Master Volume SPA-VIAGGIO



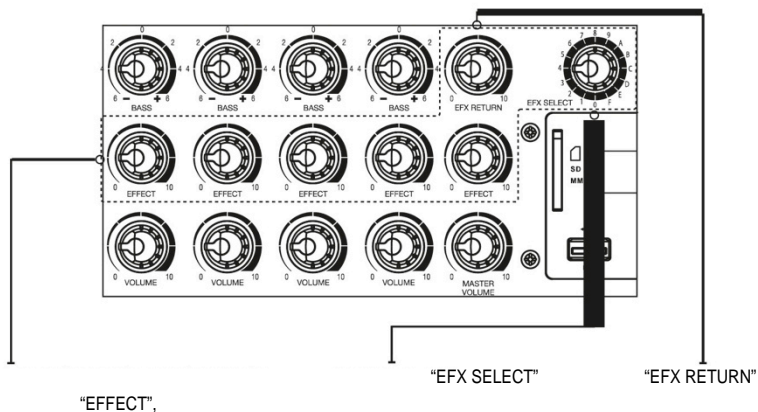

- | | |
|----------------|-------------------|
| 0. WARM HALL | 8. STEREO DELAY1 |
| 1. BRIGHT HALL | 9. STEREO DELAY 2 |
| 2. WARM ROOM | A. REV+Delay 1 |
| 3. BRIGHT ROOM | B. REV+Delay 2 |
| 4. VOCAL 1 | C. REV+Delay 3 |
| 5. VOCAL 2 | D. REV+Delay 4 |
| 6. VOCAL 3 | E. REV+CHORUS 1 |
| 7. PLATE | F. REV+CHORUS 2 |

6. : " (Master Volume) 0.

b. (-) SPA-VIAGGIO.

MIC/LINE -

d. "TREBLE" "BASS" "0"
(,)

e. " REVERB" "0".

f. , ,
"PEAK". "10",
"7"

"3", "PEAK" MIC/LINE,

g. "MASTER VOLUME"

"PHANTOM POWER" (). PHANTOM POWER

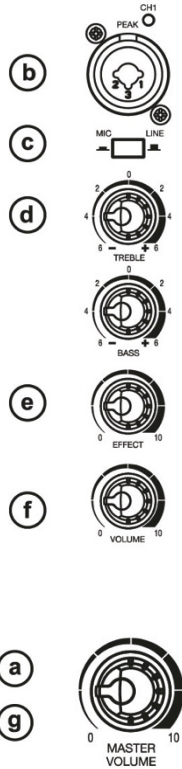

7. , - , CD MP3 5/6: "MASTER VOLUME".

a. 5/6

b. "5/6" SPA-VIAGGIO

(1/4" RCA,

).

70%.

.....

- d. "5/6 VOLUME CONTROL" 5-7.
- e. "MASTER VOLUME"
- 8. - 7/8:
 - a. "MASTER VOLUME"
 - b. "7/8" SPA-VIAGGIO
- 3,5
 - 70%.
 - d. "MASTER VOLUME"
- 9. :
(Master Volume) "1".
 - b. MONITOR OUTPUT (1/4" RCA)
 - d. "MONITOR MASTER VOLUME"
- 10. SPA-VIAGGIO
 - a. "MASTER VOLUME"
 - b.
 - c.
 - d.
 - e. ()
 - f.

g.

(1)



(2)

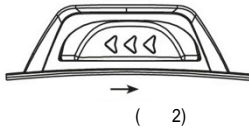

(3)

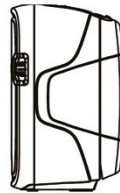

11. MP3

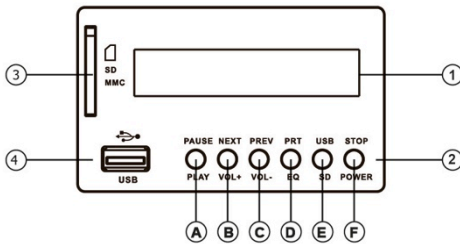

1. LCD-

MP3

2.

A. Play/ Pause (/)



•
B. Next/ Vol + (/ +) MP3

•
•
C. Previous/Vol- (/ -) MP3

D. Repeat/ EQ (/)
•
" "
•
" "
•
•

E. USB/SD USB SD/MMC.

F. Stop/Power (/) MP3

3. SD: SD (FAT32) MP3

4. USB: USB
(FAT32) MP3

.....

- :
- : 124
- (-10): 50 - 20
- : 120-240 50/60 ,

- : D (2 100 RMS)
- : 2 * 1/4 TS ()

- : 8 (4 / , 2)
- : 1-4 - XLR/ 1/4", XLR - ,
- . 5-6, 1/4" TRS (L+R),
RCA (). 7-8 - 3,5 .
- : 15
- : : 1/4" TRS
(L+R) RCA ().
- : 3,5 .
- : 1-4: = ,
= :
- :
- : +/- 6
- : 16

- : 10
- : 1
- : 2 * 1/4 TS ()
- :
- : 36
- : (. * . * .) 655*380*555

•

•

1. CE
EMC (2004/108/CE), CE (93/68/EEC)
(2006/95/EC).
2. « » WEEE (
) (2002/96/EC).
3. «RoHS compliant» (2002/95EC)

/

