

Eris™ E5 / E8

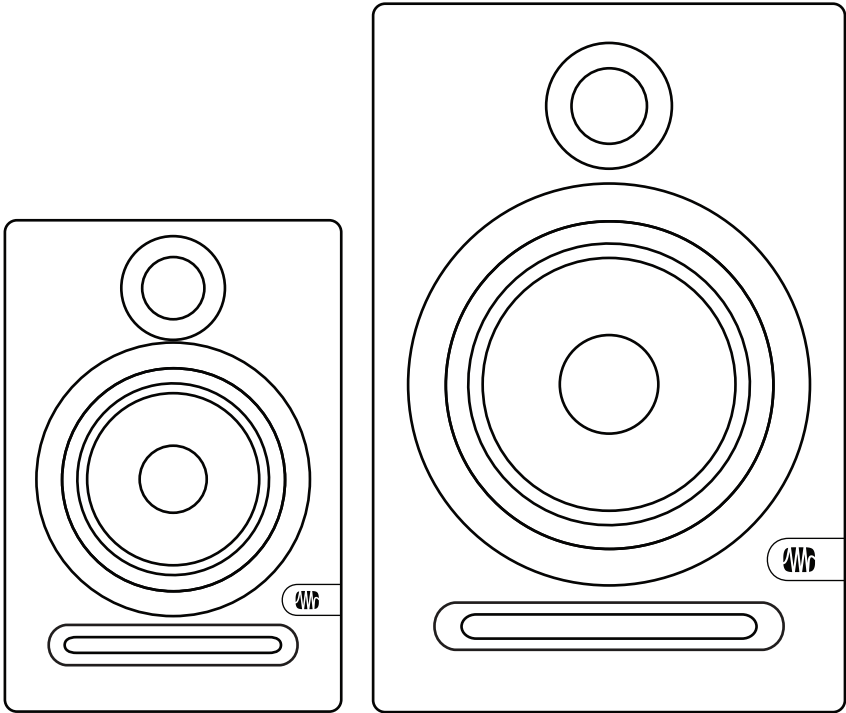



()



- 1.
- 2.
- 3.
- 4.
- 5.
- 6.
- 7.
- 8.

()

9.

10.

11.

PreSonus.

12.



13.

14.

PreSonus,
PreSonus

support@presonus.com

www.presonus.com.

15.

16.

WEEE



RoHS

2011/65/EC

ROHS.

REACH

EC1907 / 2006

(REACH)

0,1%

CE

EMC (2006/95 /)
(2004/108 / EC).



1	— 1	3	— 7
1.1	— 1	3.1	— 7
1.2	Eris E5/E8 — 2	3.2	— 8
1.3	— 2	3.3	— 8
		3.4	Acoustic Space — 9
2	— 3	4	— 10
2.1	— 3	4.1	— 10
2.1.1	— 3	4.2	— 12
2.1.2	— 4	4.3	PreSonus — 13
2.1.3	— 4		
2.2	— 5		
2.2.1	— 5		
2.2.2	— 6		

1

1.1

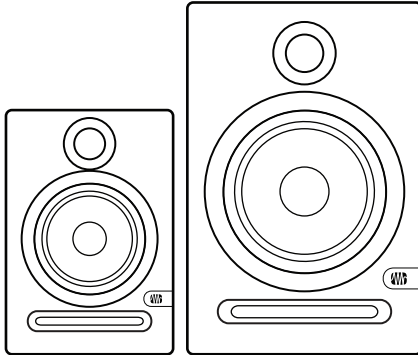

PreSonus Eris E5/E8. E5 E8 -

PreSonus Eris E5/E8,

1225-216-7887 9 17
PreSonus Audio Electronics

Eris E5/E8!

Eris

E5/E8,

Acoustic Space.

1.2

Eris E5/E8

- 3 :2 (XLR ¼" TRS) 1 (RCA)
- -
- ,
- .
- 35 .
- /
- ±6 4,5
- /
- ±6 1
- (80 , 100)
- -12 /
- Acoustic Space (0, -2 , -4)

1.3

- 1 PreSonus Eris E5 E8

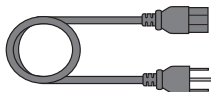
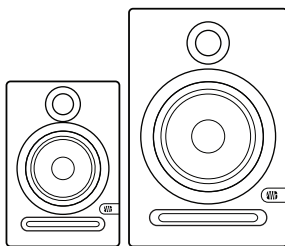

- 1 IEC



- 4 ,

2

2.1

2.1.1

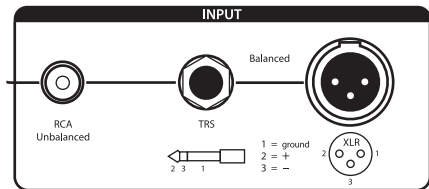

Eris E5/E8

(XLR 1/4" TRS)

(RCA).

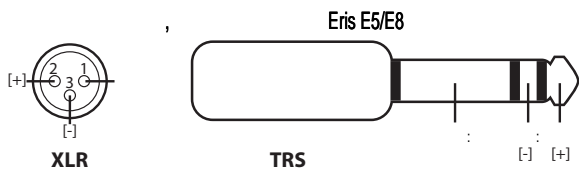

XLR 1/4" TRS (- -),

1/4" TS (-),

1/4" -RCA

Input Gain ():

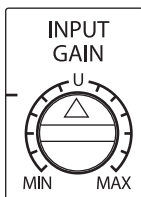

2.1.2

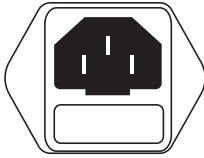

IEC: Eris E5/E8

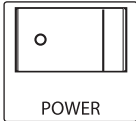

Power Switch ()

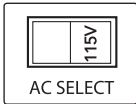

AC Select.

Eris

2.1.3

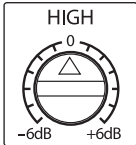

High (): 4,5 ±6 High Eris E5/E8

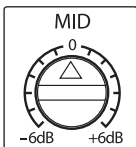

Mid (): 1 ±6 Mid -

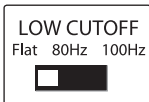

Low Cutoff (): (80 100) -12 / Flat,

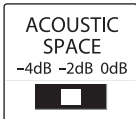

Acoustic Space: 800 (-2 -4)

0

2.2

2.2.1

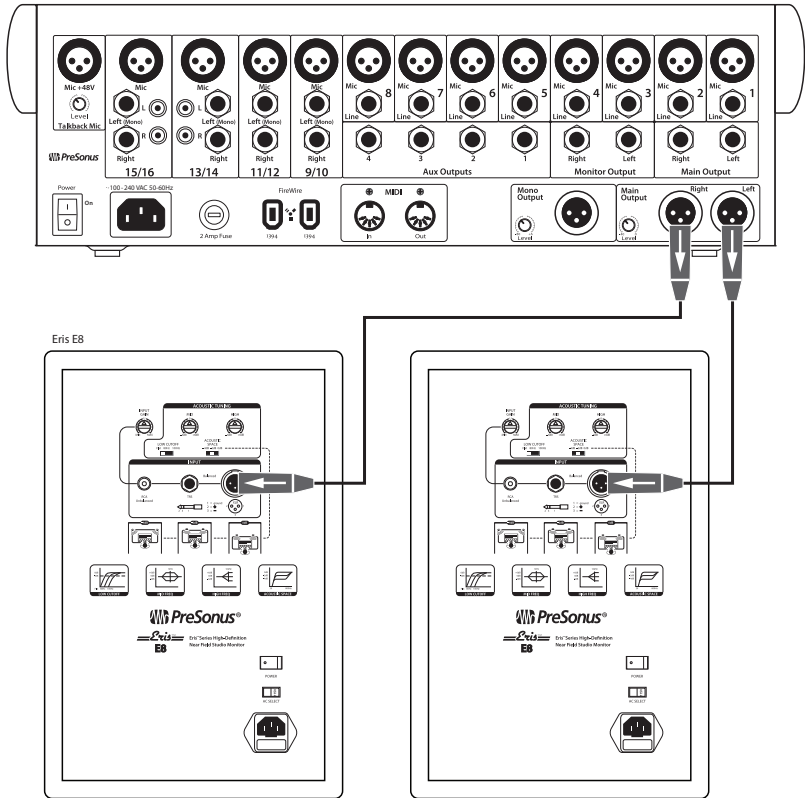

2.2.2

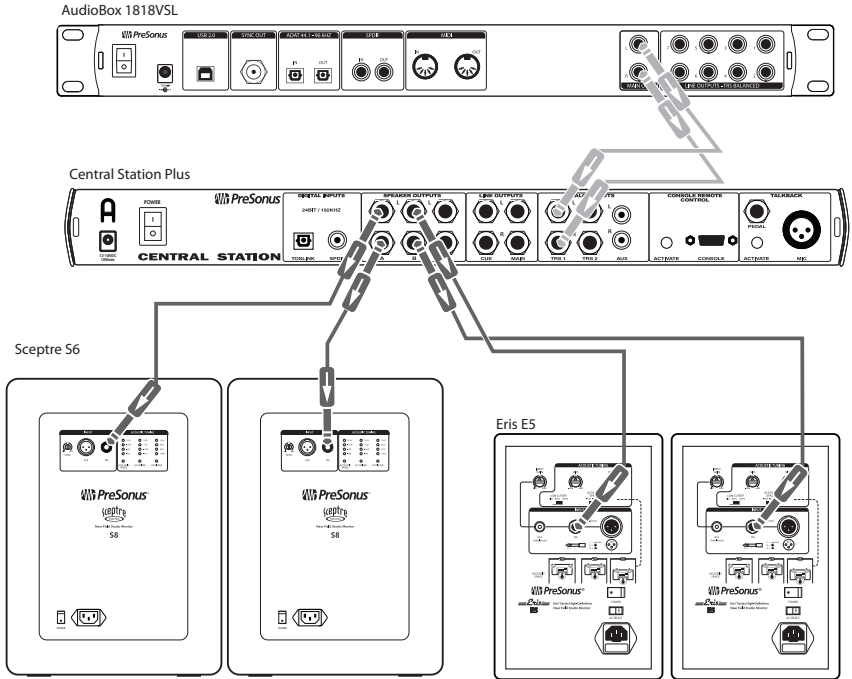

3

3.1

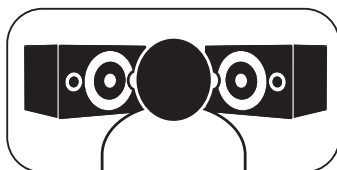
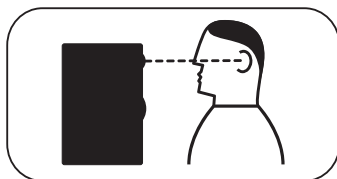

Eris

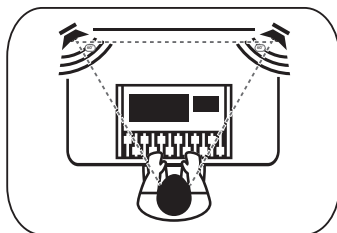

3.2

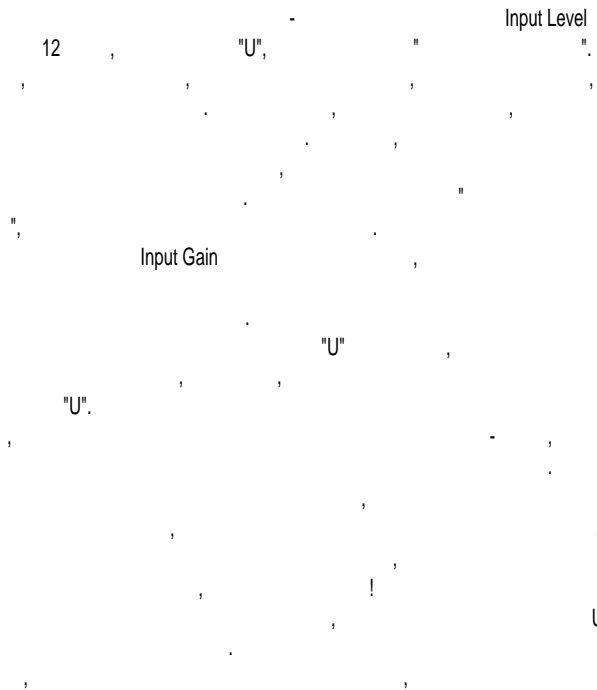
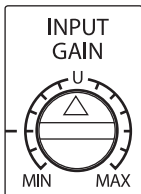

3.3

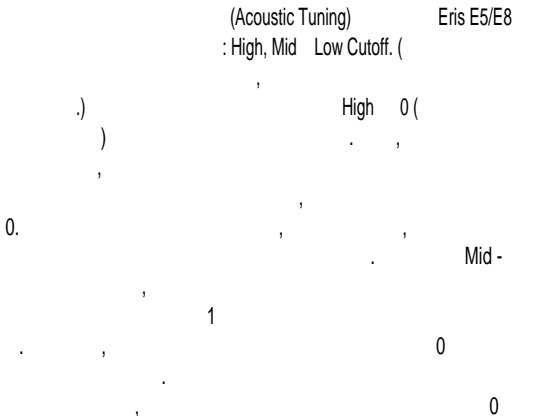
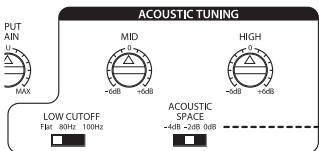

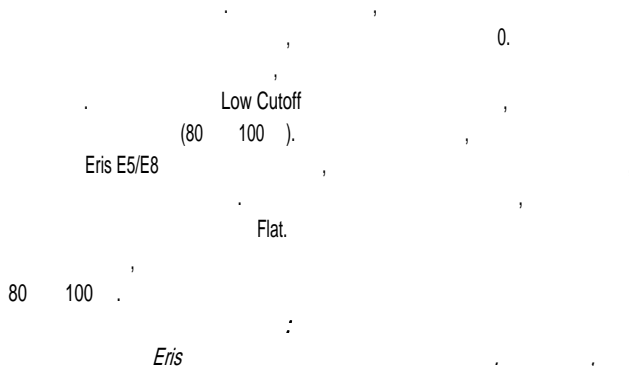

3.4 Acoustic Space.

E5/E8 Acoustic Space, 800 Acoustic Space -4 Eris

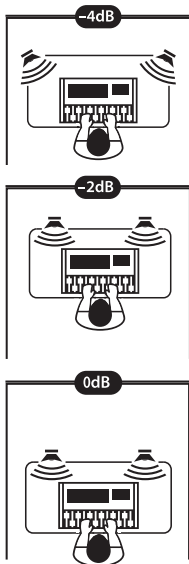

4

4.1

(E5 E8)

1	XLR.
1	¼ " TRS.
1	RCA

E5	53 - 22
E8	35 - 22

E5	3
E8	2,2

E5	45
E8	75

E5	35
E8	65

. 1 .

E5	102
E8	105

E5	5,25"
E8	8"

E5	1"
E8	1,25"

E5 and E8	10
------------------	----

E5 E8 , A

E5 E8 (-6 +6)

E5 E8 (-6 +6)

E5 E8 ,80 ,100

Acoustic Space

E5 E8 , -2 , -4

(E5 E8)

E5 E8 100-120 , ~50/60 220-240 , ~50/60

E5 E8

(, ,)

E5 178 /195 / 260

E8 250 / 299 / 384

E5 4,63

E8 10,07

4.2

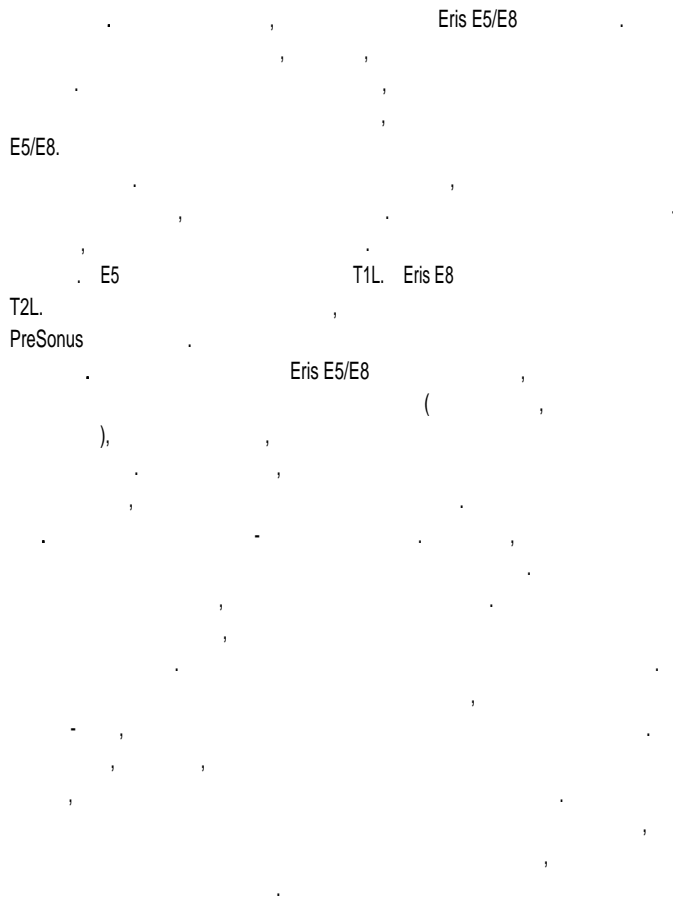

4.3 PreSonus

PreSonus Audio Electronics

(1)

14

PreSonus

PreSonus

<http://support.presonus.com>

PreSonus.

PreSonus

PreSonus

. PreSonus

PreSonus

PreSonus Audio Electronics, Inc.
7257 Florida Blvd.
Baton Rouge, LA 70806 USA
1-225-216-7887
www.presonus.com

© 2013 PreSonus Audio Electronics, Inc. AudioBox, CoActual, DigiMax, Eris, FireStudio,
Nimbit, PreSonus, QMix, Riff to Release, Sceptre, StudioLive XMAX
PreSonus Audio Electronics, Inc. Capture, Impact,
Mixverb Presence, RedLightDist, SampleOne, Studio One Tricomp
PreSonus Software Ltd. Mac OS X Apple Inc.,
. Windows
Microsoft, Inc. . Temporal EQ TQ
Fulcrum Acoustic.

Eris™ E5 / E8

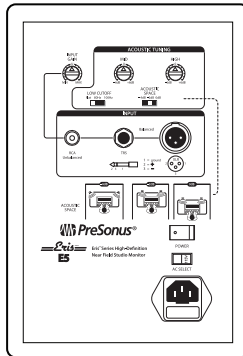
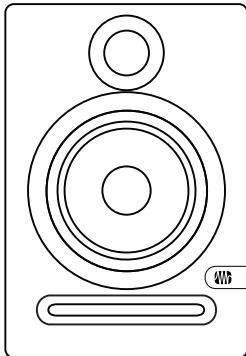
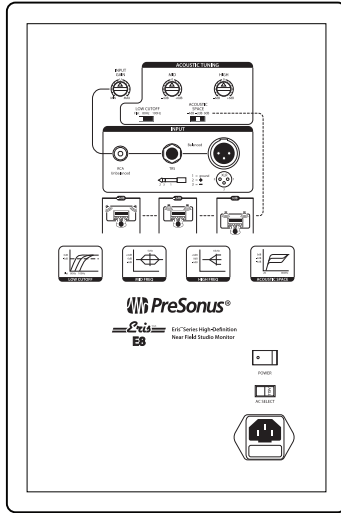
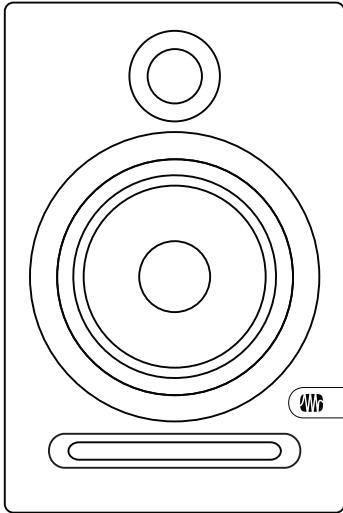

7257 Florida Boulevard • Baton Rouge,
Louisiana 70806 USA • 1-225-216-7887
www.presonus.com

Part# 820-PAE0024-C